

User Guide

24" LCD TV/DVD Combo

INSIGNIA™

NS-24LD120A13



Contents

CHILD SAFETY	1
Important Safety Instructions	2
WARNING	2
CAUTION	3
Introduction	4
Installing the stand or wall-mount bracket	4
Installing the stand	4
Installing a wall-mount bracket	4
TV/DVD combo components	5
Package contents	5
Front	5
Back	6
Remote control	7
Making connections	8
What connection should I use?	8
Connecting power	9
Connecting a cable or satellite box	9
Connecting an antenna or cable TV (no box)	12
Connecting a DVD or Blu-ray player	12
Connecting a VCR	14
Connecting a camcorder or game console	15
Connecting a computer	15
Connecting a USB flash drive	16
Connecting headphones	17
Connecting a basic home theater system	17
Connecting a home theater system with multiple devices	18
Using the remote control	18
Installing remote control batteries	18
Aiming the remote control	18
Turning on your TV/DVD combo for the first time	19
Understanding the basics	20
Turning your TV/DVD combo on or off	20
Selecting the video input source	20

- [On-screen menu overview 21](#)
- [Navigating the menus 21](#)
- [Selecting a channel 22](#)
- [Adjusting the volume 22](#)
- [Viewing channel information 22](#)
- [Viewing system information 22](#)
- [Adjusting the picture 22](#)
 - [Adjusting the TV picture 22](#)
 - [Adjusting the computer image 24](#)
- [Adjusting the sound 24](#)
 - [Adjusting sound settings 24](#)
 - [Playing TV audio only 25](#)
- [Changing channel settings 25](#)
 - [Automatically scanning for channels 25](#)
 - [Hiding channels 26](#)
 - [Setting up a favorite channel list 27](#)
 - [Viewing a favorite channel 27](#)
 - [Adding or changing a channel label 28](#)
 - [Checking the digital signal strength 28](#)
- [Setting parental controls 29](#)
 - [Setting or changing the password 29](#)
 - [Locking control buttons 30](#)
 - [Blocking unrated TV 30](#)
 - [Setting parental control levels 31](#)
 - [Downloading rating information 33](#)
- [Using closed captioning 33](#)
 - [Turning closed captioning on or off 33](#)
 - [Selecting the analog closed captioning mode 34](#)
 - [Customizing digital closed captioning styles 34](#)
- [Adjusting time settings 35](#)
 - [Setting the clock 35](#)
 - [Setting the sleep timer 36](#)
- [Adjusting menu settings 37](#)
 - [Selecting the menu language 37](#)
 - [Turning the input sensor on or off 37](#)
 - [Labeling an input source 37](#)
 - [Restoring settings to the defaults 38](#)
- [Using a USB flash drive 38](#)
 - [Switching to USB mode 38](#)

Browsing photos	39
Viewing favorite photos	39
Viewing photos in a slideshow	40
Customizing slideshow settings	40
Using the DVD player	41
Playing a disc	41
Controlling disc playback	41
Adjusting DVD player settings	41
DVD on-screen menus	42
Maintaining	44
Cleaning the TV/DVD combo cabinet	44
Cleaning the TV screen	44
Care and handling of discs	44
Troubleshooting	44
Video and audio	44
Remote control	46
General	46
Disc playback	46
USB photo display	47
Specifications	47
Programming universal remote controls	48
Programming a different universal remote control	48
Common universal remote control codes	49
Legal notices	49
One-year limited warranty - Insignia Televisions	50
Definitions:	50
How long does the coverage last?	50
What does this warranty cover?	50
How to obtain warranty service?	50
Where is the warranty valid?	50
What does the warranty not cover?	50

CHILD SAFETY

It makes a difference how and where you use your flat panel display

As you enjoy your new product, keep these safety tips in mind

The issue

The home theater entertainment experience is a growing trend, and larger TVs are popular purchases. However, TVs are not always supported on the proper stands or installed according to the manufacturer's recommendations. We and the consumer electronics industry are committed to making home entertainment enjoyable and safe.

TVs that are inappropriately placed on dressers, bookcases, shelves, desks, speakers, chests, or carts may fall over and cause injury.

Tune into safety

- One size of TV stand does **not** fit all. Use only a TV stand rated for the weight of your TV.
- Carefully read and understand all enclosed instructions for proper use of this product.
- Don't let children climb on or play with entertainment system furniture and TVs.
- Don't place TVs on furniture that can easily be used as steps, such as a crate or chest of drawers.
- Remember that children can become excited while watching a program, especially on a "larger-than-life" TV. Make sure that you place or install the TV where it cannot be pushed, pulled over, or knocked down.
- Make sure that you route all cords and cables so that they cannot be pulled or grabbed by curious children.



Wall mounting

If you decide to wall mount your TV, always remember:

- One size of wall mount does **not** fit all. Use only a wall mount rated for the weight of your TV and that has been recommended by this TV manufacturer, listed in this manual, or otherwise listed by an independent laboratory as suitable for your TV.
- Follow all instructions supplied by the TV and wall mount manufacturers.
- If you have any doubts about your ability to safely wall mount your TV, get help from a professional installer.
- Make sure that the wall where you are mounting the TV is appropriate. Some wall mounts are not designed to be mounted to walls backed with steel studs or cinder blocks. If you are unsure, ask a professional installer.



TVs can be heavy. At least two people are required for safe wall mount installation.

Important Safety Instructions



This symbol indicates that dangerous voltage constituting a risk of electric shock is present within your TV/DVD combo. This label is located on the back of your TV/DVD combo.



This symbol indicates that there are important operating and maintenance instructions in the literature accompanying your TV/DVD combo.

- 1 Read these instructions.
- 2 Keep these instructions.
- 3 Heed all warnings.
- 4 Follow all instructions.
- 5 Do not use this apparatus near water.
- 6 Clean only with dry cloth.
- 7 Do not block any ventilation openings. Install in accordance with the manufacturer's instructions.
- 8 Do not install near any heat sources such as radiators, heat registers, stoves, or other apparatus (including amplifiers) that produce heat.
- 9 Do not defeat the safety purpose of the polarized or grounding-type plug. A polarized plug has two blades with one wider than the other. A grounding type plug has two blades and a third grounding prong. The wide blade or the third prong are provided for your safety. If the provided plug does not fit into your outlet, consult an electrician for replacement of the obsolete outlet.
- 10 Protect the power cord from being walked on or pinched particularly at plugs, convenience receptacles, and the point where they exit from the apparatus.
- 11 Only use attachments/accessories specified by the manufacturer.
- 12 Use only with the cart, stand, tripod, bracket, or table specified by the manufacturer, or sold with the apparatus. When a cart is used, use caution when moving the cart/apparatus combination to avoid injury from tip-over.
- 13 Unplug this apparatus during lightning storms or when unused for long periods of time.



53125A

- 14 Refer all servicing to qualified service personnel. Servicing is required when the apparatus has been damaged in any way, such as power-supply cord or plug is damaged, liquid has been spilled or objects have fallen into the apparatus, the apparatus has been exposed to rain or moisture, does not operate normally, or has been dropped.
- 15 The *wall plug* is the disconnecting device. The plug must remain readily operable.
- 16 An apparatus with three-prong, grounding-type plug is a Class I apparatus which needs to be grounded to prevent possible electric shock. Make sure that you connect the Class I apparatus to a grounding-type, three-prong outlet.
- 17 Remote control batteries should not be exposed to excessive heat such as sunshine, fire, or the like.
- 18 The apparatus should not be exposed to dripping or splashing and no objects filled with liquids, such as vases, should be placed on the apparatus.

WARNING

Electric shock hazard

To reduce the risk of fire or electric shock, do not remove any cover or expose the device to rain or moisture. No user-serviceable parts are inside. Refer servicing to qualified service technicians.

Lightning

For added protection for your device receiver during a lightning storm, or when it is left unattended and unused for long periods of time, unplug it from the power outlet and disconnect any antenna or cable system. This helps prevent property damage and personal injury from lightning and power line surges.

Power lines

An outside antenna system should not be located in the vicinity of overhead power lines or other electric light or power circuits, or where it can fall into such power lines or circuits. When installing an outside antenna system, extreme care should be taken to keep from touching such power lines or circuits as contact with them might be fatal.

Handling the LCD panel

- Your TV's screen is made of glass. Do not drop your TV/DVD combo or hit, jolt, or press hard against the LCD panel. If the screen breaks, be careful of broken glass.
- If the LCD panel is broken, make absolutely sure that you do not touch the liquid in the panel. This may cause skin inflammation.
- If the liquid gets in your mouth, immediately gargle, rinse, and consult with your doctor. Also, if the liquid gets in your eyes or touches your skin, consult with your doctor after rinsing for at least 15 minutes or longer in clean water.

Replacement parts

When replacement parts are required, make sure that the service technician uses replacement parts specified by the manufacturer that have the same characteristics as the original part. Unauthorized substitutions may result in fire, electric shock, personal injury, or other hazards.

Safety check

After completing any service or repair to this device, ask the service technician to perform routine safety checks to determine that your TV/DVD combo is in correct operating condition.

Power source

Operate your TV/DVD combo only from the type of power source indicated on the marking label. If you are not sure of the type of power supplied to your home, consult an electrician or your local power company.

Servicing

These servicing instructions are for use by qualified service personnel only. To reduce the risk of electric shock, do not perform any servicing other than that contained in the operating instructions unless you are qualified to do so.

CAUTION

Damage requiring service

Unplug this TV/DVD combo from the power outlet and refer servicing to qualified service personnel under the following conditions:

- When the power supply cord or plug is damaged or frayed.
- If liquid has been spilled or objects have fallen into your TV/DVD combo.
- If your TV/DVD combo has been exposed to rain or water.
- If your TV/DVD combo does not operate normally by following the operating instructions. Adjust only those controls that are covered by the operating instructions because incorrect adjustment of other controls may result in damage and will often require extensive work by a qualified technician to restore your TV/DVD combo to its normal operation.
- If your TV/DVD combo has been dropped or damaged in any way.
- When your TV/DVD combo exhibits a distinct change in performance.

Outdoor antenna grounding

If an outside antenna or cable system is connected to your TV/DVD combo, make sure that the antenna or cable system is grounded to provide some protection against voltage surges and built-up static charges. Article 810 of the National Electrical Code, ANSI/NFPA No. 70, provides information with respect to correct grounding of the mast and supporting structure, grounding of the lead-in wire to an antenna discharge unit, size of grounding conductors, location of the antenna-discharge unit, connection to grounding electrodes, and requirements for the grounding electrode.

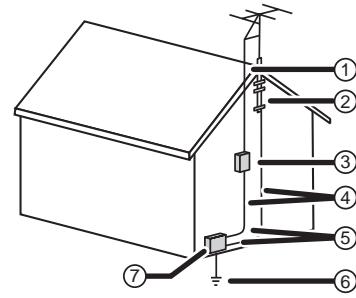

- ① Antenna lead-in wire
- ② Grounding clamp
- ③ Antenna discharge unit
- ④ Grounding conductors
- ⑤ Ground clamps
- ⑥ Power service grounding electrode system
- ⑦ Electric service equipment

Note to CATV system installer

Article 820 of the National Electrical Code, ANSI/NFPA No. 40 provides guidance for correct grounding. Specifically, it states that the cable ground must be connected to the grounding system of the building as close to the point of cable entry as practical.

Condensation

Moisture will form on the TV/DVD combo if the TV/DVD combo is brought from cool surroundings into a warm room or if the temperature of the room rises suddenly. When this happens, the TV/DVD combo's performance may be impaired. To prevent this, let the TV/DVD combo stand in its new surroundings for about an hour before switching it on, or make sure that the room temperature rises gradually.

Condensation may also form during the summer if the TV/DVD combo is exposed to the breeze from an air conditioner. In such cases, change the location of the TV/DVD combo.

Mobile telephone warning

To avoid interference with your TV picture and sound, operating problems, or even damage, keep your cordless and cellular telephones away from the TV/DVD combo.

End of life directives

Your TV/DVD combo contains tin-lead solder and a fluorescent lamp containing a small amount of mercury. Disposal of these materials may be regulated for environmental reasons. Your TV/DVD combo also contains material that can be recycled and reused. For disposal or recycling information, contact your local authorities to find a recycler in your area.

Non-active pixels

The LCD panel contains almost 3 million thin film transistors, which provide exceptionally sharp video quality. Occasionally, a few non-active pixels may appear on the screen as a fixed blue, green, or red point. These non-active pixels do not adversely affect the performance of your TV/DVD combo, and are not considered defects.

Insignia 24" LCD TV/DVD Combo

Introduction

Congratulations on your purchase of a high-quality Insignia product. Your NS-24LD120A13 represents the state of the art in LCD TV and DVD player design and is designed for reliable and trouble-free performance.

Installing the stand or wall-mount bracket

Notes

- If you plan to wall-mount your TV/DVD combo, do not install the stand.
- Store the stand and stand screws in case you decide to use the stand in the future.

Installing the stand

To install the stand:

- 1 Carefully place your TV screen face-down on a cushioned, clean surface to protect the screen from damages and scratches.

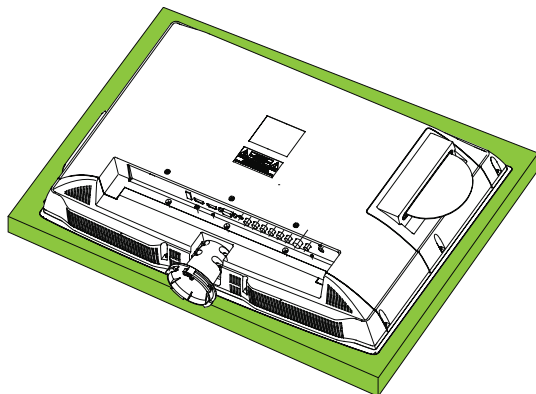

- 2 Align the stand with the stand column, then rotate the stand in the direction of the arrow until you hear the stand lock into place.

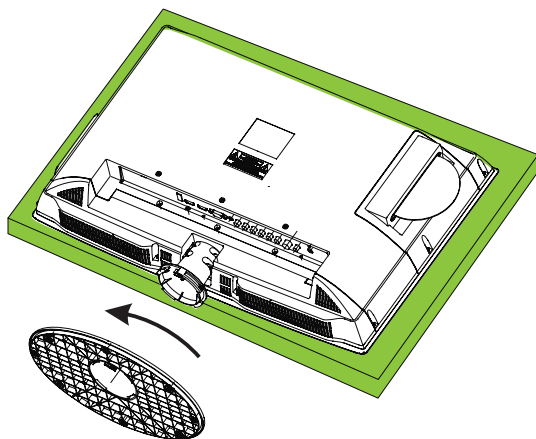

Installing a wall-mount bracket

Warning

This TV/DVD combo is intended to be supported by a UL Listed wall mount bracket with suitable weight/load. (See "Miscellaneous" on page 48.)

To attach your TV/DVD combo to a wall-mount bracket:

- 1 Carefully place your TV screen face-down on a cushioned, clean surface to protect the screen from damages and scratches.
- 2 If the stand is attached, press and hold the PUSH button while you rotate the stand to remove it.

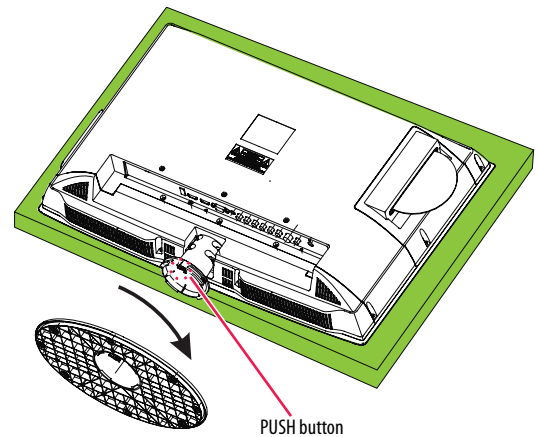

- 3 Remove the six screws that secure the stand column to the TV screen.

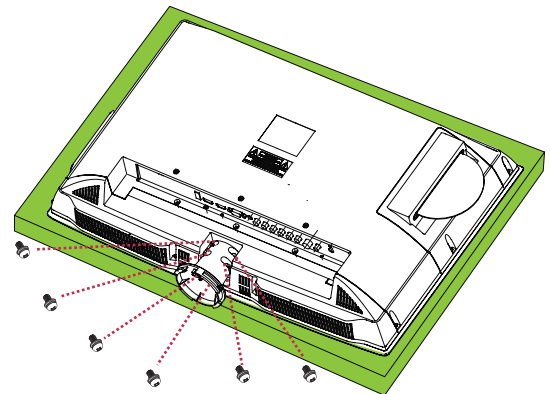

4 Remove the stand column.

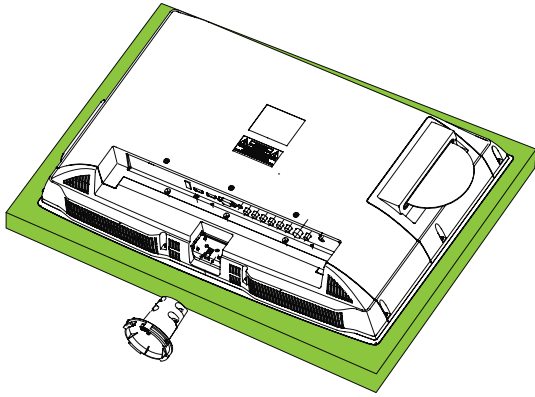

5 Attach the wall-mount bracket to your TV/DVD combo using the mounting holes on the back of your TV/DVD combo. See the instructions that came with the wall-mount bracket for information about how to correctly hang your TV/DVD combo.

Note

- The length of the wall-mount screws vary depending on the wall-mount bracket you purchased. See the instructions that came with the wall-mount bracket for screw lengths.
- The mounting holes on the back of your TV/DVD combo take type M4 screws.

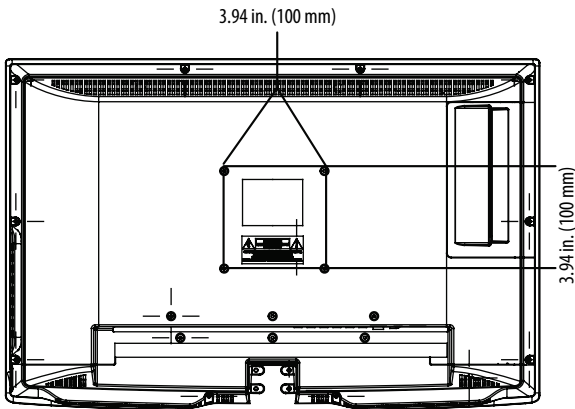

TV/DVD combo components

Package contents

- Remote control and batteries (2 AAA)
- Stand
- *Quick Setup Guide*
- *Important Information*

Front

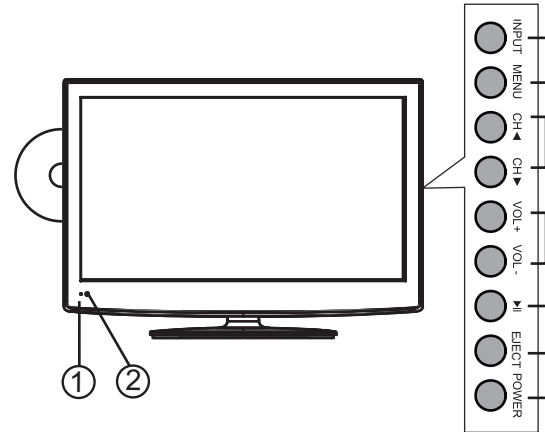

#	Item	Description
①	Power indicator	Turns off when your TV/DVD combo is on. Lights red when your TV/DVD combo is off (standby mode).
②	Remote control sensor	Receives signals from the remote control. Do not block.
③	INPUT	Press to open the <i>INPUT SOURCE</i> list, press CH ▲ or CH ▼ to select a video input source, then press INPUT again. For more information, see " Selecting the video input source " on page 20. In menu mode, press to confirm selections.
④	MENU	Press to open the on-screen menu. For more information, see " Navigating the menus " on page 21.
⑤	CH ▲/CH ▼	Press to go to the next or previous channel in the channel list. For more information, see " Selecting a channel " on page 22.
⑥	VOL+/VOL-	Press to increase or decrease the volume.
⑦	▶ (play/pause)	Press to start or pause disc playback
⑧	EJECT	Press to eject a disc from the disc slot.
⑨	POWER	Press to turn your TV/DVD combo on or off (standby mode). When your TV/DVD combo is off, power still flows through it. To completely disconnect power, unplug the power cord.

Back

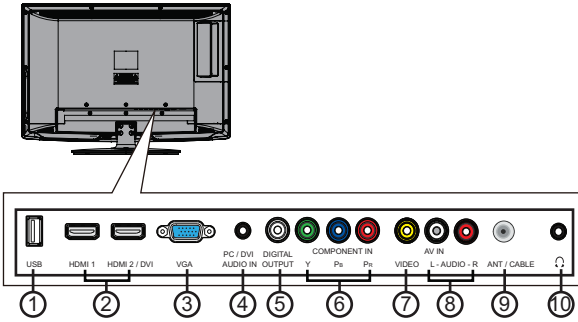

#	Item	Description
①	USB	Connect a USB flash drive to this jack to view compatible JPEG picture files. For more information, see "Connecting a USB flash drive" on page 16 and "Using a USB flash drive" on page 38.
②	HDMI 1 and HDMI 2/DVI	Connect HDMI devices to these jacks. For more information see "Using HDMI (best)" on page 9 or 12. Connect the video for a DVI device to the HDMI 2/DVI jack. For more information, see "Using DVI (same as HDMI but requires a sound connection)" on page 10 or 13.
③	VGA	Connect the video for a computer to this jack. For more information, see "Connecting a computer" on page 15.
④	PC/DVI AUDIO IN	Connect the audio for a computer to this jack. For more information, see "Connecting a computer" on page 15. OR Connect the audio for a DVI device to the this jack. For more information, see "Using DVI (same as HDMI but requires a sound connection)" on page 10 or page 13.
⑤	DIGITAL OUTPUT (coaxial)	Connect a digital audio amplifier or home theater system to this jack to listen to TV audio through the amplifier speakers. For more information, see "Connecting a basic home theater system" on page 17.
⑥	COMPONENT IN Y, Pb, Pr	Connect the video for a component video device to these jacks. For more information, see "Using component video (better)" on page 10 or 13.
⑦	AV IN VIDEO	Connect the video for a composite video device to the this jack. For more information, see "Using composite video (good)" on page 11 or 14.
⑧	AV IN L/R (audio)	The component video jacks (COMPONENT IN Y, Pb, and Pr) share these audio jacks with the composite video jack (AV IN VIDEO). Connect the audio for a component video device to these jacks. For more information, see "Using component video (better)" on page 10 or 13. OR Connect the audio for a composite video device to these jacks. For more information, see "Using composite video (good)" on page 11 or 14.
⑨	ANT/CABLE	Connect an antenna or cable TV to this jack. For more information, see "Connecting an antenna or cable TV (no box)" on page 12.
⑩	⦿ (headphone)	Connect headphones to this jack. For more information, see "Connecting headphones" on page 17.

Remote control

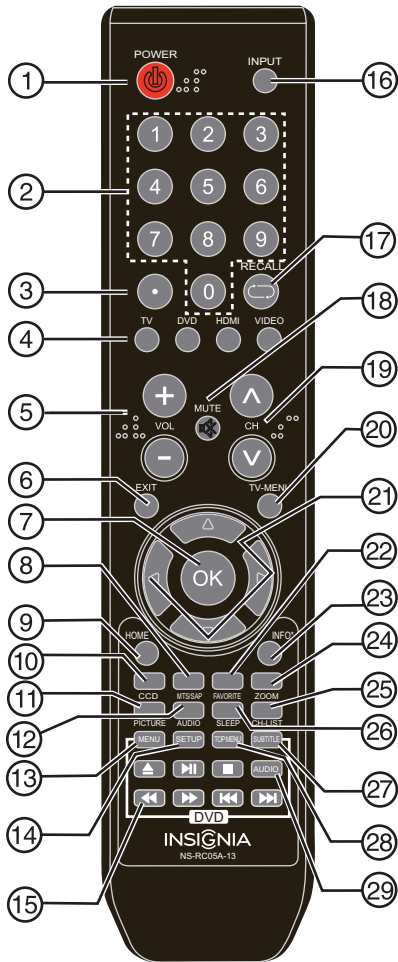







#	Button	Description
①	⏻ (power)	Press to turn your TV/DVD combo on or off (standby mode). When your TV/DVD combo is off, power still flows through it. To disconnect power, unplug the power cord.
②	Numbers	Press to enter channel numbers and the parental control password.
③	●	Press to enter a digital sub-channel number. For more information, see "Selecting a channel" on page 22.
④	Quick Launch Inputs	TV —Press to select your TV as the input source. DVD —Press to select the DVD player as the input source. HDMI —Press one or more times to select the device connected to the HDMI 1 or HDMI 2/DVI jack. VIDEO —Press to select the device connected to the COMPONENT IN jacks or AV IN VIDEO jack.
⑤	VOL+/-	Press to increase or decrease the volume.
⑥	EXIT	Press to close the on-screen menu.
⑦	OK	Press to confirm selections or changes.
⑧	MTS/SAP	Press to select the audio mode for an analog program. You can select: <ul style="list-style-type: none"> • MONO—Select this option if there is noise or static on weak stereo broadcasts. • STEREO—Select this option for programs broadcast in stereo.
⑨	HOME	This button has no function.

#	Button	Description
⑩	CCD	Press to turn closed captioning on or off. You can select CC Off , CC On , or CC On when Mute . For more information, see "Turning closed captioning on or off" on page 33.
⑪	PICTURE	Press to select the picture mode. You can select Vivid , Standard , Energy Savings , Theater , Sports , or Custom . For more information, see "Picture Mode" in "Adjusting the TV picture" on page 22.
⑫	AUDIO	Press to select the sound mode. You can select Standard , News , Music , Theater , or Custom . For more information, see "Sound Mode" in "Adjusting sound settings" on page 24.
⑬	MENU	Press to open the DVD menu.
⑭	SETUP	Press to open the DVD setup menu.
⑮	DVD playback controls	<ul style="list-style-type: none"> ▲ (eject) ▶▶ (play/pause) ■ (stop) ◀◀ (fast reverse) ▶▶ (fast forward) ◀◀ (previous chapter) ▶▶ (next chapter)
⑯	INPUT	Press to open the <i>INPUT SOURCE</i> list, press ▲ or ▼ on the remote control to select the video input source, then press OK . For more information, see "Selecting the video input source" on page 20.
⑰	○ (return)	In TV mode, press to return to the previous channel. In USB mode, press to go back to a higher level folder.
⑱	🔇 /MUTE	Press to mute the sound. Press again to restore the sound.
⑲	CH ▲/CH ▼	Press to change TV channels. For more information, see "Selecting a channel" on page 22.
⑳	TV-MENU	Press to open the on-screen menu.
㉑	▲ ▼ ◀ ▶	Press to navigate in on-screen menus and to adjust settings.
㉒	FAVORITE	Press to open the <i>Favorite</i> channel list. For more information, see "Setting up a favorite channel list" on page 27 and "Viewing a favorite channel" on page 27.
㉓	INFO	Press to display TV status information, such as the channel number, channel name (if available), or signal source. For more information, see "Viewing channel information" on page 22.
㉔	ZOOM	Press to change how the picture looks on the screen (aspect ratio). For more information, see "Aspect ratio options" on page 23.
㉕	CH-LIST	Press to open the channel list.
㉖	SLEEP	Press to set the sleep timer. You can select Off , 5 , 10 , 15 , 30 , 60 , 90 , 120 , 180 , or 240 minutes. For more information, see "Setting the sleep timer" on page 36.
㉗	SUBTITLE	Press to select a DVD subtitle language, if available.
㉘	TOP MENU	Press to open the DVD title menu.
㉙	AUDIO	Press to select a different DVD audio language, if available.

Making connections

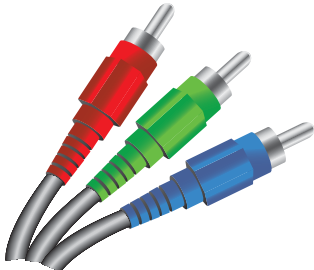
What connection should I use?

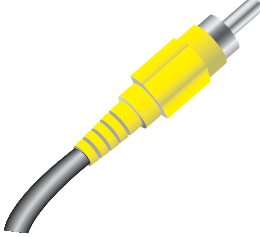
Your TV/DVD combo has several connection types for connecting devices to your TV/DVD combo. For the best video quality, you should connect a device to the best available connection. Use the following tables to identify cables:

Connection type and jack	Video quality	Cable connector
 <p>HDMI video/audio</p>	<p>Best (use this if your devices have HDMI)</p>	
 <p>Component video (requires an audio connection)</p>	<p>Better than composite or coaxial</p>	
 <p>Composite video (requires an audio connection)</p>	<p>Better than coaxial</p>	
 <p>Coaxial video/audio</p>	<p>Good</p>	

Connection type and jack	Cable connectors
--------------------------	------------------

Coaxial digital audio



Analog audio

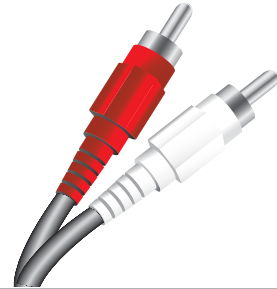

VGA (computer) video and audio

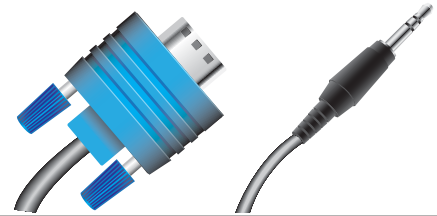
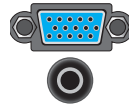

You can use the **HDMI 2/DVI** jack on your TV/DVD combo to connect a DVI device to your TV/DVD combo. You need to attach an HDMI-to-DVI adapter to the end of the HDMI cable that connects to the DVI device.

Cautions

- Check the jacks for position and type before making any connections.
- Loose connections can result in image or color problems. Make sure that all connections are tight and secure.
- The external audio/video equipment shown may be different from your equipment. If you have questions, refer to the documentation that came with your equipment.
- Always unplug the power cord when connecting external equipment.

Connecting power

To connect the power:

- Plug the AC power cord into a power outlet.

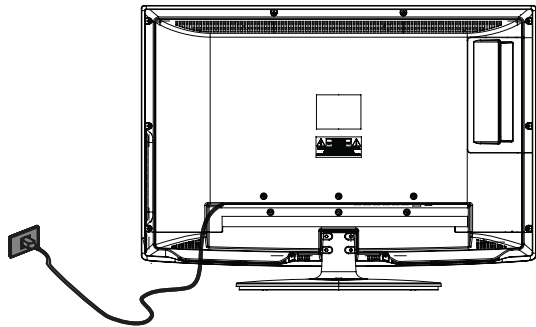

Cautions

- Your TV/DVD combo should only be operated from the power source indicated on the label.
- Always unplug the AC power cord from the power outlet when you will not be using your TV/DVD combo for an extended period of time.

Connecting a cable or satellite box

Many cable or satellite TV boxes have more than one connection type. To get the best video, you should use the best connection type available. For more information, see "[What connection should I use?](#)" on page 8.

Using HDMI (best)

To connect a cable or satellite box using HDMI:

- 1 Make sure that your TV/DVD combo's power cord is unplugged, and all connected equipment is turned off.
- 2 Connect the incoming cable from the cable wall jack to the cable-in jack on the cable or satellite box.
- 3 Connect an HDMI cable (not provided) to one of the **HDMI** jacks on the back of your TV/DVD combo and to the **HDMI OUT** jack on the cable or satellite box.

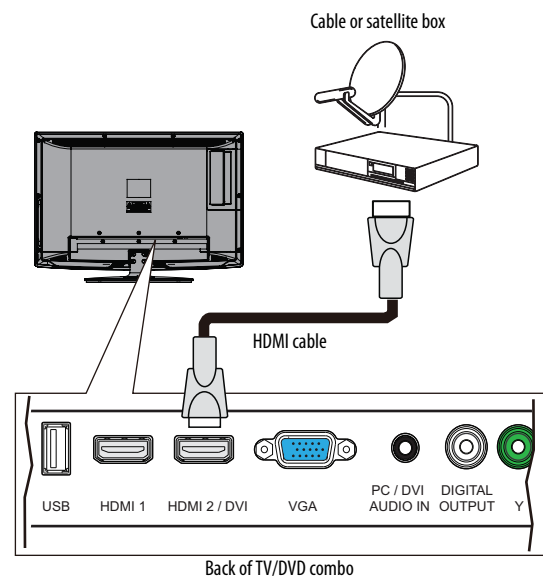

- 4 Plug your TV/DVD combo's power cord into a power outlet, turn on your TV/DVD combo, then turn on the cable or satellite box.
- 5 Go through the Setup Wizard on page 19.

Note

An HDMI cable carries both audio and video. You do not need to use any audio cables.

Using DVI (same as HDMI but requires a sound connection)

Note

You must use the **HDMI 2/DVI** jack to connect a cable or satellite box using DVI. If you use another **HDMI** jack, you will not hear sound.

To connect a cable or satellite box using DVI:

- 1 Make sure that your TV/DVD combo's power cord is unplugged, and all connected equipment is turned off.
- 2 Connect the incoming cable from the cable wall jack to the cable-in jack on the cable or satellite box.
- 3 Connect an HDMI-DVI adapter (not provided) to one end of an HDMI cable (not provided), then connect the adapter to the **DVI OUT** jack on the cable or satellite box.
- 4 Connect the other end of the cable to the **HDMI 2/DVI** jack on the back of your TV/DVD combo.

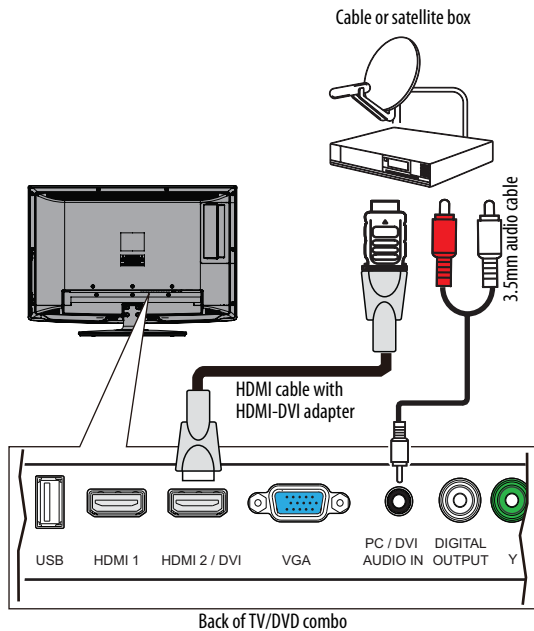

- 5 Connect a 3.5mm audio cable (not provided) to the **PC/DVI AUDIO IN** jack on the back of your TV/DVD combo and to the **AUDIO OUT** jacks on the cable or satellite TV box.

Note

When you connect the audio using the **PC/DVI AUDIO IN** jack, the audio output is analog.

- 6 Plug your TV/DVD combo's power cord into a power outlet, turn on your TV/DVD combo, then turn on the cable or satellite TV box.
- 7 Go through the Setup Wizard on page 19.

Using component video (better)

To connect a cable or satellite box using component video:

- 1 Make sure that your TV/DVD combo's power cord is unplugged, and all connected equipment is turned off.
- 2 Connect the incoming cable from the cable wall jack to the cable-in jack on the cable or satellite box.
- 3 Connect a component video cable (not provided) to the **COMPONENT IN Y, Pb, and Pr** video jacks on the back of your TV/DVD combo and the component video out jacks on the cable or satellite box.

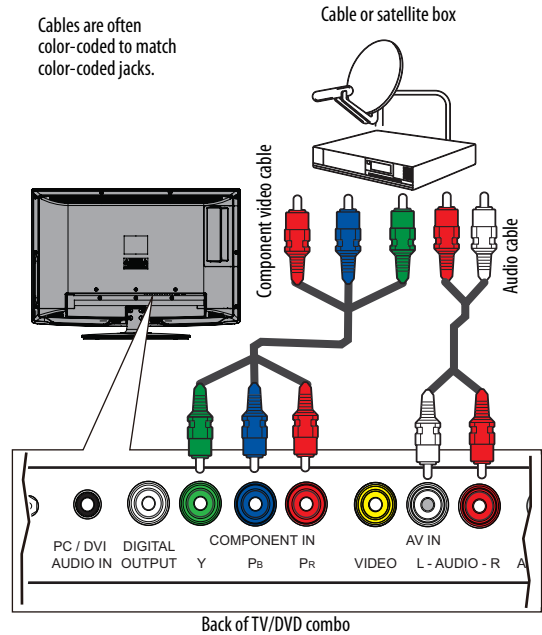

- 4 Connect an audio cable (not provided) to the **AV IN L/R AUDIO** jacks on the back of your TV/DVD combo and to the audio out jacks on the cable or satellite TV box.

Note

- The **COMPONENT IN** video jacks share the **AV IN L/R AUDIO** jacks with the **AV IN VIDEO** jack.
- When you connect the audio using the **AV IN L/R AUDIO** audio jacks, the audio output is analog.

- 5 Plug your TV/DVD combo's power cord into a power outlet, turn on your TV/DVD combo, then turn on the cable or satellite TV box.
- 6 Go through the Setup Wizard on page 19.

Using composite video (good)

To connect a cable or satellite box using composite video:

- 1 Make sure that your TV/DVD combo's power cord is unplugged, and all connected equipment is turned off.
- 2 Connect the incoming cable from the cable wall jack to the cable-in jack on the cable or satellite box.
- 3 Connect an A/V cable (not provided) to the **AV IN VIDEO** jack and **L/R AUDIO** jacks on the back of your TV/DVD combo and to the composite video and audio out jacks on the cable or satellite box.

Note

- The **AV IN VIDEO** jack shares the **AV IN L/R AUDIO** jacks with the **COMPONENT IN** video jacks.
- When you connect the audio using the **AV IN L/R AUDIO** jacks, the audio output is analog.

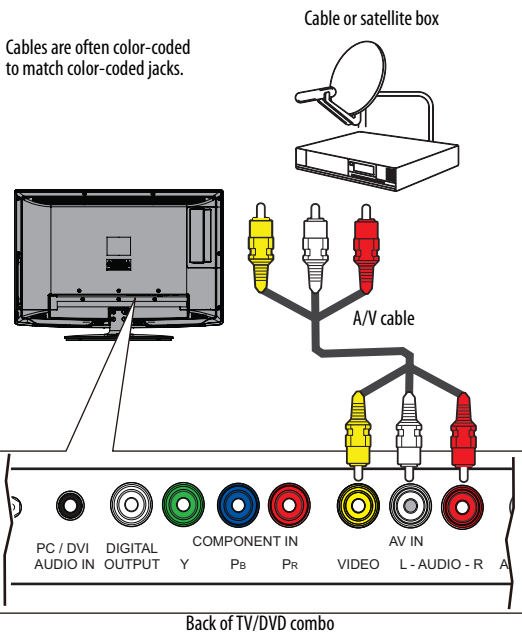

- 4 Plug your TV/DVD combo's power cord into a power outlet, turn on your TV, then turn on the cable or satellite TV box.
- 5 Go through the Setup Wizard on page [19](#).

Using coaxial (good)

To connect a cable or satellite box using coaxial:

- 1 Make sure that your TV/DVD combo's power cord is unplugged, and all connected equipment is turned off.
- 2 Connect the incoming cable from the cable wall jack to the cable-in jack on the cable or satellite box.
- 3 Connect a coaxial cable (not provided) to the **ANT/CABLE** jack on the back of your TV/DVD combo and to the coaxial out jack on the cable or satellite box.

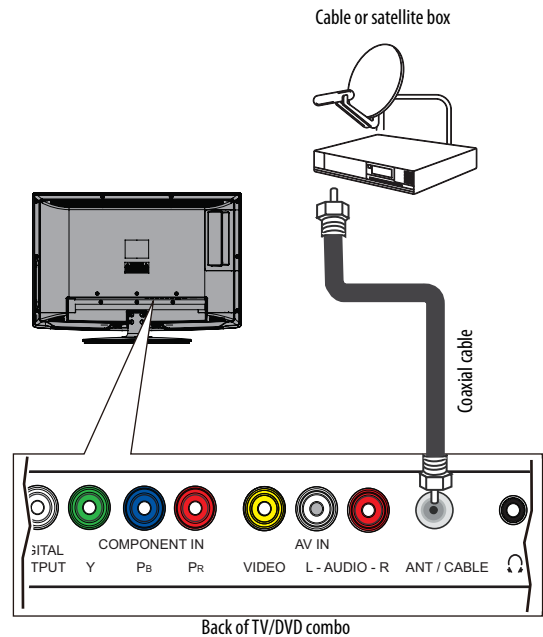

- 4 Plug your TV/DVD combo's power cord into a power outlet, turn on your TV, then turn on the cable or satellite TV box.
- 5 Go through the Setup Wizard on page [19](#).

Notes

- Use a coaxial cable to eliminate interference and noise from radio waves.
- Do not bundle the coaxial cable with the power cord or other cables.

Connecting an antenna or cable TV (no box)

To connect an antenna or cable TV (no box):

- 1 Make sure that your TV/DVD combo's power cord is unplugged, and all connected equipment is turned off.
- 2 Connect a coaxial cable to the **ANT/CABLE** jack on the back of your TV/DVD combo and to the antenna or cable TV wall jack.

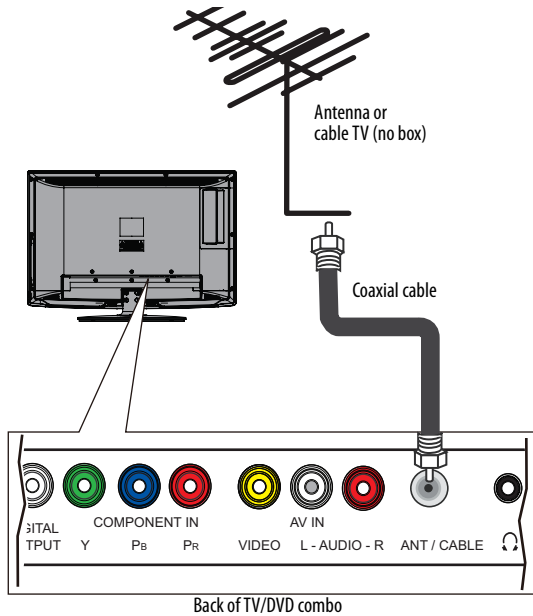

- 3 Plug your TV/DVD combo's power cord into a power outlet, then turn on your TV/DVD combo.
- 4 Go through the Setup Wizard on page 19.

Notes

- Use a coaxial cable to eliminate interference and noise from radio waves.
- Do not bundle the coaxial cable with the power cord or other cables.
- If the antenna is not installed correctly, contact qualified service personnel to correct the problem.
- If the signal level for a channel is weak, the picture may be distorted. Adjust the antenna or use a highly directional outdoor or set-top antenna with a built-in amplifier.
- If the picture quality is good on some channels and poor on others, the problem may be caused by a poor or weak signal from the broadcaster or cable TV provider.
- If you connect to cable or satellite TV without a set-top box and experience poor picture quality, you may need to install a set-top box to improve signal reception and picture quality. Contact your cable or satellite TV provider about upgrading to a set-top box.
- Many high-definition (HD) channels upscale standard-definition (SD) content. The picture displayed on your TV/DVD combo is still displayed as SD, thus the picture quality will not be as clear or crisp as it would be if the content was originally recorded in HD.

Connecting a DVD or Blu-ray player

Using HDMI (best)

To connect a DVD or Blu-ray player using HDMI:

- 1 Make sure that your TV/DVD combo's power cord is unplugged and the DVD or Blu-ray player is turned off.
- 2 Connect an HDMI cable (not provided) to one of the **HDMI** jacks on the back of your TV/DVD combo and to the **HDMI OUT** jack on the DVD or Blu-ray player.

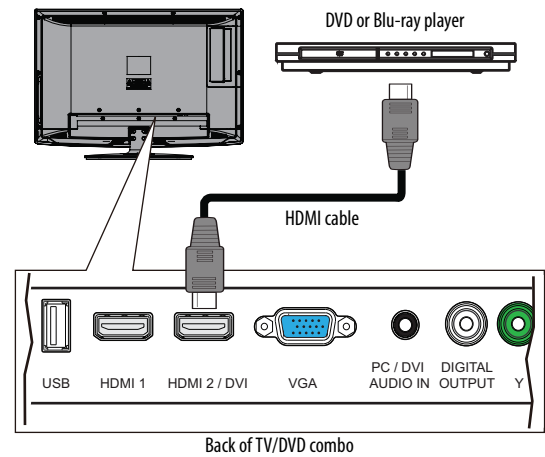

- 3 Plug your TV/DVD combo's power cord into a power outlet, then turn on your TV/DVD combo.
- 4 Turn on the DVD or Blu-ray player, then set it to the correct output mode. For more information, see the documentation that came with the player.
- 5 Press **INPUT** to open the *INPUT SOURCE* list.
- 6 Press **▲** or **▼** to highlight **HDMI 1** or **HDMI 2**, then press **OK**.

Note

You can also press **HDMI** repeatedly to select the DVD or Blu-ray player.

Using DVI (same as HDMI but requires a sound connection)

Note

You must use the **HDMI 2/DVI** jack to connect a DVD or Blu-ray player using DVI. If you use another **HDMI** jack, you will not hear sound from the TV/DVD combo speakers.

To connect a DVD or Blu-ray player using DVI:

- 1 Make sure that your TV/DVD combo's power cord is unplugged and the DVD or Blu-ray player is turned off.
- 2 Connect an HDMI-DVI adapter (not provided) to one end of an HDMI cable (not provided), then connect the adapter to the **DVI OUT** jack on the DVD or Blu-ray player.
- 3 Connect the other end of the cable to the **HDMI 2/DVI** jack on the back of your TV/DVD combo.

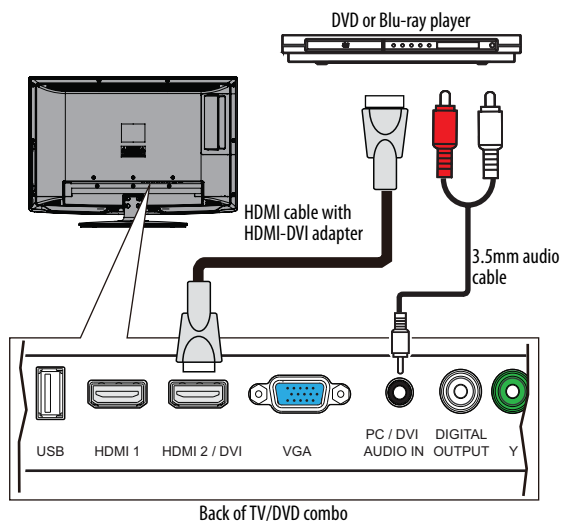

- 4 Connect a 3.5mm audio cable (not provided) to the **PC/DVI AUDIO IN** jack on the back of your TV/DVD combo and to the **AUDIO OUT** jacks on the DVD or Blu-ray player.
- 5 Plug your TV/DVD combo's power cord into a power outlet, then turn on your TV/DVD combo.
- 6 Turn on the DVD or Blu-ray player, then set it to the correct output mode. For more information, see the documentation that came with the player.
- 7 Press **INPUT** to open the **INPUT SOURCE** list.
- 8 Press **▲** or **▼** to select **HDMI 2**, then press **OK**.

Note

You can also press **HDMI** one or more times to select the DVD or Blu-ray player.

Using component video (better)

To connect a DVD or Blu-ray player using component video:

- 1 Make sure that your TV/DVD combo's power cord is unplugged and the DVD or Blu-ray player is turned off.
- 2 Connect a component video cable (not provided) to the **COMPONENT IN Y, Pb, and Pr** jacks on the back of your TV/DVD combo and to the **COMPONENT OUT** jacks on the component video device.

Cables are often color-coded to match color-coded jacks.

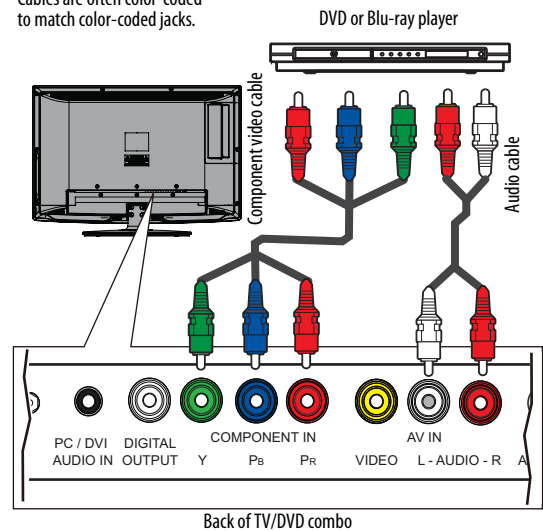

- 3 Connect an audio cable to the **AV IN L/R AUDIO** jacks on the back of your TV/DVD combo and to the **L/R AUDIO OUT** jacks on the DVD or Blu-ray player.

Notes

- The **COMPONENT IN** video jacks share the **AV IN L/R AUDIO** jacks with the **AV IN VIDEO** jack.
- When you connect the audio using the **AV IN L/R AUDIO** jacks, the audio output is analog.

- 4 Plug your TV/DVD combo's power cord into a power outlet, then turn on your TV/DVD combo.
- 5 Turn on the DVD or Blu-ray player, then set it to the correct output mode. For more information, see the documentation that came with the player.
- 6 Press **INPUT** to open the **INPUT SOURCE** list.
- 7 Press **▲** or **▼** to select **Component**, then press **OK**.

Note

You can also press **VIDEO** to select the DVD or Blu-ray player.

Using composite video (good)

To connect a DVD or Blu-ray player using composite video:

- 1 Make sure that your TV/DVD combo's power cord is unplugged and the DVD or Blu-ray player is turned off.
- 2 Connect an AV cable (not provided) to the **AV IN Video** jack and **L/R AUDIO** jacks on the back of your TV/DVD combo and to the **AV OUT** jacks on the DVD or Blu-ray player.

Note

- The **AV IN VIDEO** jack shares the **AV IN L/R AUDIO** jacks with the **COMPONENT IN** video jacks.
- When you connect the audio using the **AV IN L/R AUDIO** jacks, the audio output is analog.

Cables are often color-coded to match color-coded jacks.

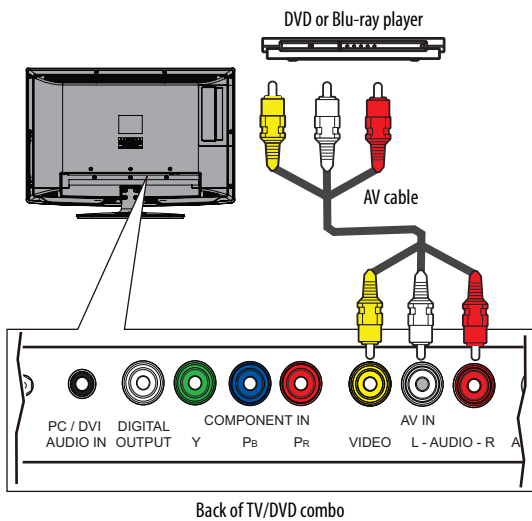

- 3 Plug your TV/DVD combo's power cord into a power outlet, then turn on your TV/DVD combo.
- 4 Turn on the DVD or Blu-ray player, then set it to the correct output mode. For more information, see the documentation that came with the player.
- 5 Press **INPUT** to open the *INPUT SOURCE* list.
- 6 Press **▲** or **▼** to select **AV**, then press **OK**.

Notes

You can also press **VIDEO** to select the DVD or Blu-ray player.

Connecting a VCR

To connect a VCR:

- 1 Make sure that your TV/DVD combo's power cord is unplugged and the VCR is turned off.
- 2 Connect an AV cable (not provided) to the **AV IN VIDEO** and **L/R AUDIO** jacks on the back of your TV/DVD combo and to the **AV OUT** jacks on the VCR.

Note

- The **AV IN VIDEO** jack shares the **AV IN L/R AUDIO** jacks with the **COMPONENT IN** video jacks.
- When you connect the audio using the **AV IN L/R AUDIO** jacks, the audio output is analog.

Cables are often color-coded to match color-coded jacks.

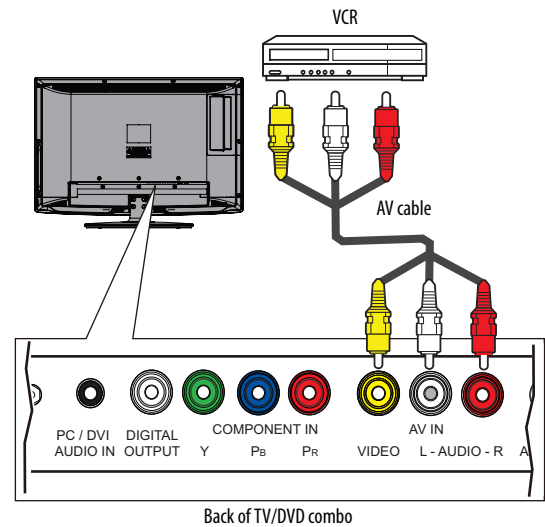

- 3 Plug your TV/DVD combo's power cord into a power outlet, then turn on your TV/DVD combo and the VCR.
- 4 Press **INPUT** to open the *INPUT SOURCE* list.
- 5 Press **▲** or **▼** to select **AV**, then press **OK**.

Note

You can also press **VIDEO** to select the VCR.

- 6 Insert a videotape in the VCR, then press **PLAY** on the VCR.

Connecting a camcorder or game console

Note

If your camcorder or game console has an HDMI connection, we recommend that you use the HDMI connection to get the best quality possible.

To connect a camcorder or game console:

- 1 Make sure that your TV/DVD combo's power cord is unplugged and the camcorder or game console is turned off.
- 2 Connect an AV cable (not provided) to the **AV IN VIDEO** and **L/R AUDIO** jacks on the back of your TV/DVD combo and to the **AV OUT** jacks on the camcorder or game console.

Note

- The **AV IN VIDEO** jack shares the **AV IN L/R AUDIO** jacks with the **COMPONENT IN** video jacks.
- When you connect the audio using the **AV IN L/R AUDIO** jacks, the audio output is analog.

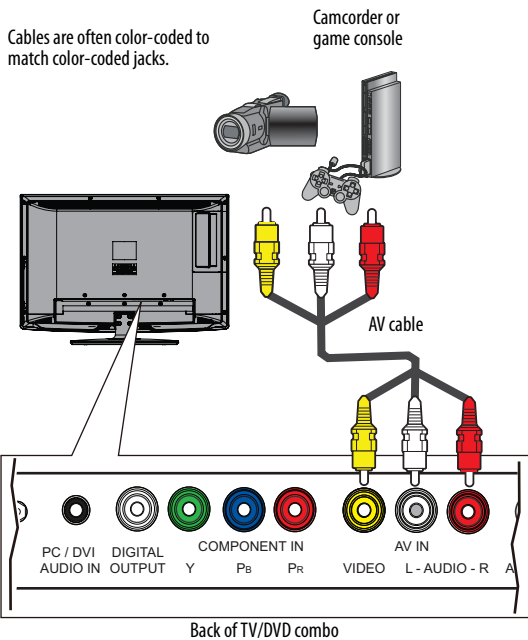

- 3 Plug your TV/DVD combo's power cord into a power outlet, turn on your TV/DVD combo.
- 4 Turn on the camcorder or game console, then set it to the correct output mode. For more information, see the documentation that came with the camcorder or game console.
- 5 Press **INPUT** to open the *INPUT SOURCE* list.
- 6 Press **▲** or **▼** to select **AV**, then press **OK**.

Notes

You can also press **VIDEO** to select the camcorder or game console.

Connecting a computer

Using VGA

To connect a computer using VGA:

- 1 Make sure that your TV/DVD combo's power cord is unplugged and the computer is turned off.
- 2 Connect a VGA cable (not provided) to the **PC IN VGA** jack on the back of your TV/DVD combo and to the **VGA** jack on the computer.

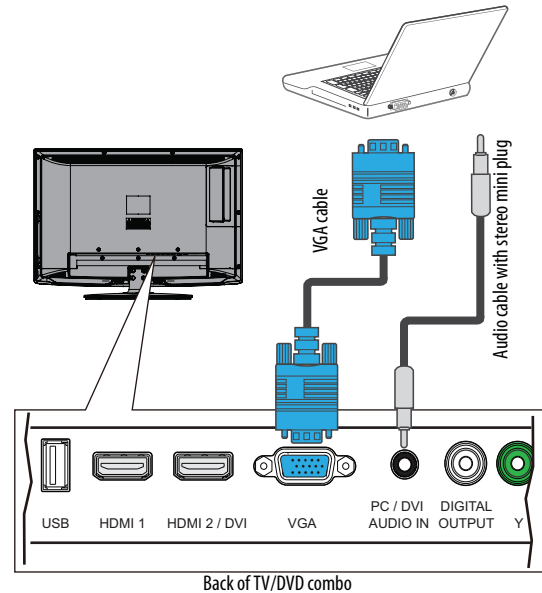

- 3 Connect an audio cable with a stereo mini plug (not included) to the **PC/DVI AUDIO IN** jack on the back of your TV/DVD combo and to the **AUDIO OUT** jack on the computer.
- 4 Plug your TV/DVD combo's power cord into a power outlet, then turn on your TV/DVD combo and the computer.
- 5 Press **INPUT** to open the *INPUT SOURCE* list.
- 6 Press **▲** or **▼** to select **VGA**, then press **OK**.
- 7 Adjust the display properties on the computer, if necessary.

Using HDMI

To connect a computer using HDMI:

- 1 Make sure that your TV/DVD combo's power cord is unplugged and the computer is turned off.
- 2 Connect an HDMI cable (not provided) to one of the **HDMI** jacks on the back of your TV/DVD combo and to the **HDMI OUT** jack on the computer.

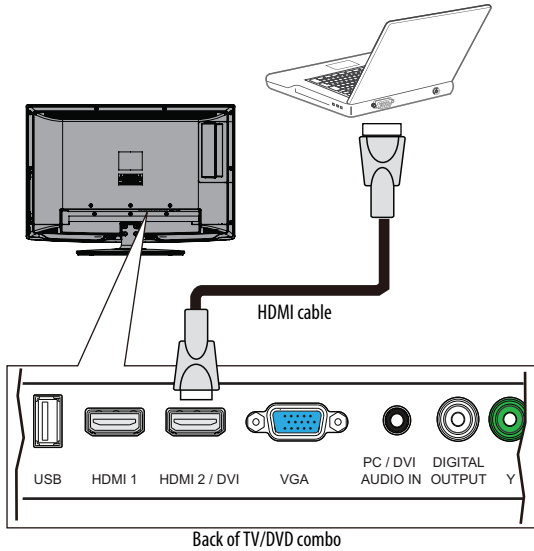

- 3 Plug your TV/DVD combo's power cord into a power outlet, then turn on your TV/DVD combo and the computer.
- 4 Press **INPUT** to open the *INPUT SOURCE* list.
- 5 Press **▲** or **▼** to highlight **HDMI1** or **HDMI2**, then press **OK**.

Note

You can also press **HDMI** repeatedly to select the computer.

- 6 Adjust the display properties on the computer, if necessary.

Connecting a USB flash drive

To connect a USB flash drive:

- 1 Plug a USB flash drive into the **USB** port on the back of your TV/DVD combo.

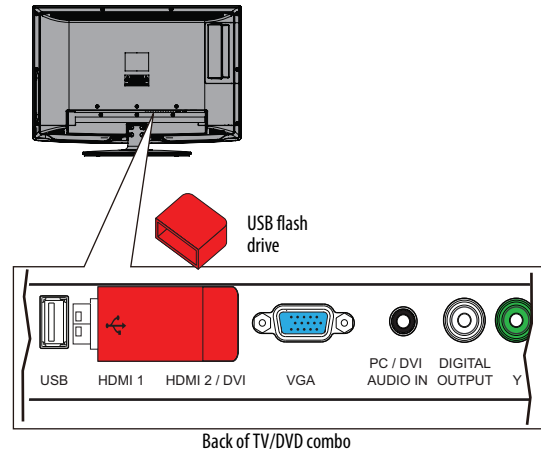

Caution

Do not remove the USB flash drive or turn off your TV/DVD combo while using the USB flash drive. You may lose data or damage the USB flash drive.

- 2 Turn on your TV/DVD combo.
- 3 Press **INPUT** to open the *INPUT SOURCE* list.
- 4 Press **▲** or **▼** to select **USB**, then press **OK**.

Note

The **Photos** viewer only supports JPEG format images (with ".jpg" file extensions) and not all JPEG files are compatible with your TV/DVD combo. For more information, see "[Using a USB flash drive](#)" on page 38.

Connecting headphones

The TV/DVD combo speakers are muted when headphones are attached.

Warning

Loud noise can damage your hearing. When using headphones, use the lowest volume setting on your headphones that still lets you hear the sound.

To connect headphones:

- Connect the headphones to the  (headphone) jack on the back of your TV/DVD combo.

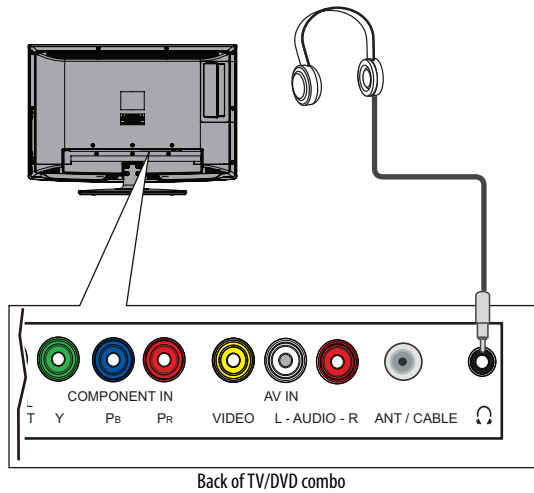

Connecting a basic home theater system

To connect a basic home theater system using digital audio:

- 1 Make sure that your TV/DVD combo's power cord is unplugged and the home theater system is turned off.
- 2 Connect a digital optical audio cable (not provided) to the **DIGITAL OUTPUT** jack on the back of your TV/DVD combo and to the optical **AUDIO IN** jack on the digital home theater system.

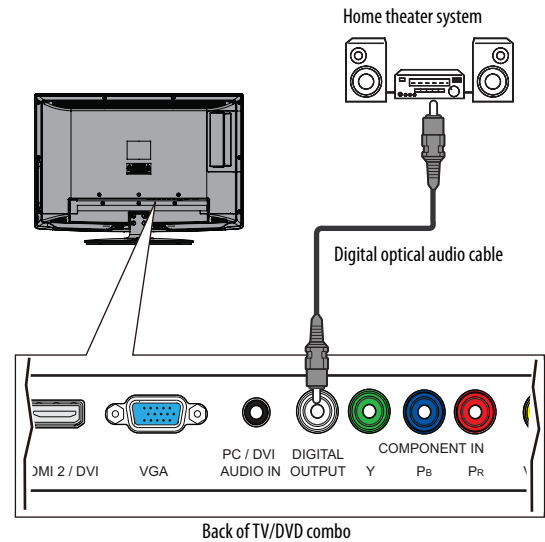

Connecting a home theater system with multiple devices

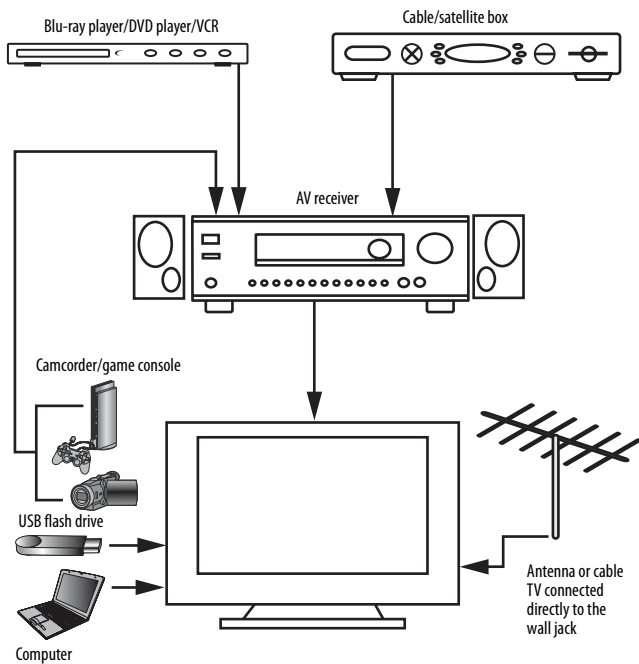

The connections you make depend on the video and audio jacks available on your devices. Refer to the documentation that came with your devices for connection information.

Just remember to use the best connection types available for the best picture and sound. For information about connection types, see [“What connection should I use?”](#) on page 8.

Using the remote control

Installing remote control batteries

To install remote control batteries:

- 1 While pressing the release latch on the back of the remote control, lift the battery compartment cover off of the remote control.

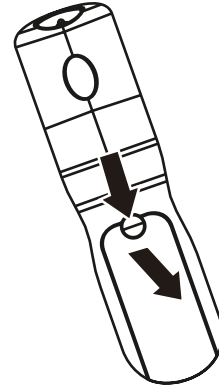

- 2 Insert two AAA batteries into the battery compartment. Make sure that you match the + and - symbols on the batteries with the + and - symbols in the battery compartment.

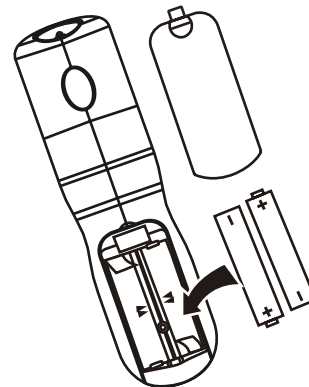

- 3 Replace the battery compartment cover.

Cautions

- Batteries should not be exposed to excessive heat, such as sunshine, heat registers, or fire.
- Battery chemicals can cause a rash. If the batteries leak, clean the battery compartment with a cloth. If chemicals touch your skin, wash immediately.
- Make sure that batteries are disposed of correctly. Do not burn or incinerate.

Notes

- Do not mix batteries of different types.
- Do not mix old and new batteries.
- Remove batteries when the charge is depleted.
- If the remote control is not going to be used for an extended period of time, remove the batteries.

Aiming the remote control

To aim the remote control:

- Point the remote control towards the remote sensor on the front of your TV/DVD combo.

Turning on your TV/DVD combo for the first time

The first time you turn on your TV/DVD combo, the Setup Wizard opens. The Setup Wizard guides you through setting up basic settings including the menu language, time setting, picture mode, TV signal source, and the channel list.

To set up your TV/DVD combo:

- 1 Make sure that you have:
 - Installed the remote control batteries. (See page 18 for details.)
 - Connected an antenna, cable TV, or satellite TV. (See page 9 through 12 for details.)
 - Connected the power cord. (See page 9 for details.)
- 2 Press (power) to turn on your TV/DVD combo. The *Choose Your Menu Language* screen opens.



- 3 Press or to highlight the language you want, then press **OK**. The *Choose Your Time Setting* screen opens.

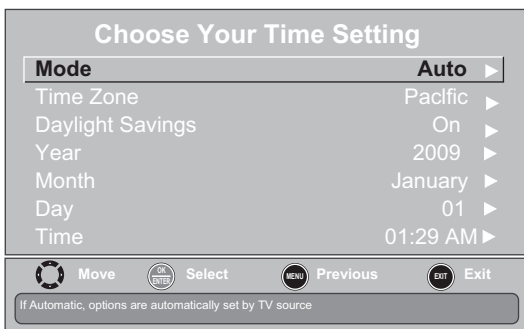

- 4 Press or to highlight **Mode**, then press or to select **Manual** (to set the date and time manually) or **Auto** (to set the date and time automatically from a TV signal source based on the time zone you select).

Note

If you select **Auto**, the displayed time will be incorrect until your TV/DVD combo gets the correct time from a TV signal source.

- 5 Press or to highlight **Time Zone**, then press or to select your time zone. You can select **Eastern, Central, Mountain, Pacific, Alaska, Hawaii, Atlantic, or Newfoundland**.
- 6 Press or to highlight **Daylight Savings**, then press or to select **On** (if your viewing area observes Daylight Savings Time) or **Off** (if your viewing area does not observe Daylight Savings Time).
- 7 If you selected **Manual** for **Mode**, set the date by pressing or to highlight **Year, Month, or Day**, then pressing or to adjust the setting.
- 8 If you selected **Manual** for **Mode**, set the time by pressing or to highlight **Time**, then pressing or to select the hour, minute, or AM/PM field. Press or to adjust the setting.
- 9 Press **OK**. The *Choose Your Picture Mode* screen opens.

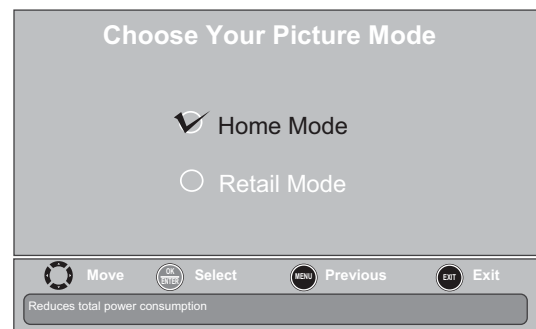

- 10 Press or to highlight **Home Mode** or **Retail Mode**, then press **OK**.

If you selected **Retail Mode**, the message "If you select Retail Mode, then Energy savings is not realized" appears. Select **Yes** to continue using **Retail Mode**, or select **No** to change your selection, then press **OK**.

The *Choose Your TV Source* screen opens.

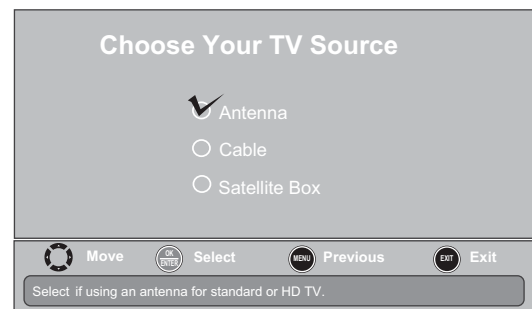

- 11 Press or to highlight **Antenna, Cable, or Satellite Box**, then press **OK**.
 - A. If you select **Antenna**, your TV scans for available channels. The scan may take several minutes.

B. If you select **Cable**, a message asks if you have a cable box.

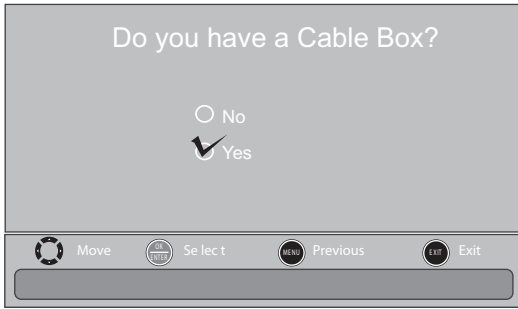

- Select **No** if no cable box is connected. Your TV scans for available channels. The scan may take several minutes.
- Select **Yes** if a cable box is connected. A message asks how you connected the cable box to your TV.

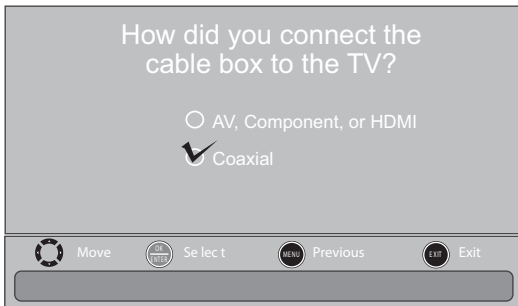

- Select **AV, Component, or HDMI** if you connected a cable box to your TV using one of these cables. Read the message, then press **OK** to close the wizard.
- Select **Coaxial** if you connected a cable box to your TV using a coaxial cable. Read the message, then press **OK** to start the channel scan (VHF channels only).

C. If you select **Satellite Box**, a message asks how you connected the satellite box to your TV.

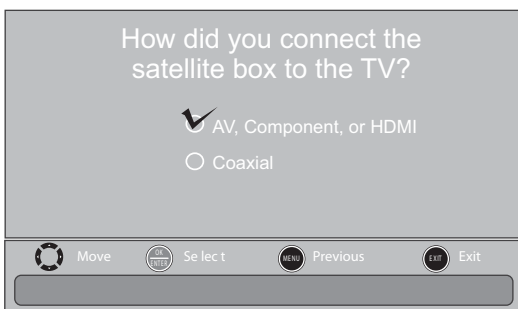

- Select **AV, Component, or HDMI** if you connected a satellite box to your TV using one of these cables. Read the message, then press **OK** to close the wizard.
- Select **Coaxial** if you connected a satellite box to your TV using a coaxial cable. Read the message, then press **OK** to start the channel scan (VHF channels only).

Note

You can press **EXIT** to stop the auto channel search, but you will need to run the auto channel search again to create a channel list.

- 12 To watch TV, press **INPUT**, press **▲** or **▼** to highlight the video input source for your TV/DVD combo in the *INPUT SOURCE* list, then press **OK**.
 - If your TV/DVD combo is connected to an antenna, cable TV (no box), or cable or satellite TV box using a coaxial cable, select **TV**.
 - If your TV/DVD combo is connected to a cable or satellite box using an HDMI cable or HDMI cable with a DVI adapter, select **HDMI 1** or **HDMI 2**.
 - If your TV/DVD combo is connected to a cable or satellite box using a component video cable, select **Component**.
 - If your TV/DVD combo is connected to a cable or satellite box using a composite video cable, select **AV**.

Understanding the basics

Turning your TV/DVD combo on or off

To turn your TV/DVD combo on or off:

- 1 Make sure that the power cord is connected to a power outlet.
- 2 Press **⏻** (power) to turn on your TV/DVD combo. The power indicator turns blue.
- 3 Press **⏻** (power) again to turn off your TV/DVD combo. Your TV/DVD combo enters standby mode, and the power indicator LED turns red.

Warning

When your TV/DVD combo is in standby mode, it is still receiving power. To completely disconnect power, unplug the power cord.

Note

If your TV/DVD combo does not receive an input signal for several minutes, it automatically goes into standby mode.

Selecting the video input source

To select the video input source:

- 1 Turn on your TV/DVD combo, then press **INPUT**. The *INPUT SOURCE* list opens.

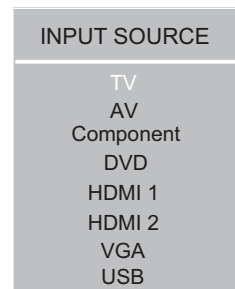

- 2 Press **▲** or **▼** to select a video input source, then press **OK**.

You can also press a Quick Launch Input button to select the video input source.

- Press **TV** to select **TV** (if your TV/DVD combo is connected to an antenna, cable TV (no box), or cable or satellite TV using a coaxial cable).
- Press **VIDEO** to select component or composite input.
- Press **HDMI** one or more times to cycle between the HDMI inputs.

On-screen menu overview

Notes

- Depending on the signal source selected, you may see different options on your screen. The following menus are shown in TV mode (except the *Photos* menu).
- Menu items that are not selectable are grayed out.
- Menus in this manual are described in TV mode, unless otherwise indicated.
- The screens shown in this manual are for explanation purposes and may vary from the actual screens on your TV/DVD combo.

Picture menu (TV mode)

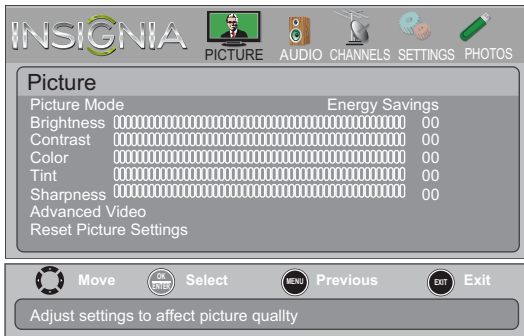

Audio menu (TV mode)

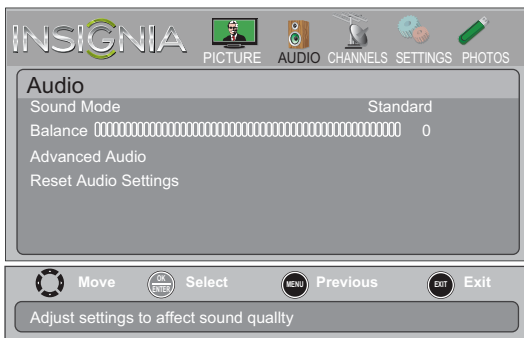

Channels menu (TV mode)

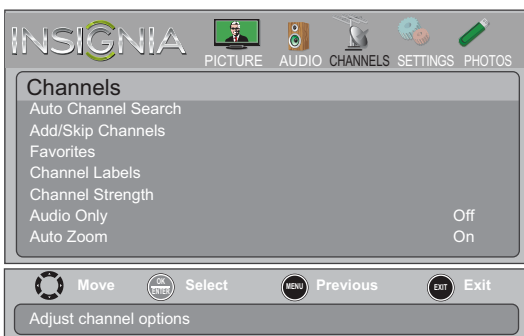

Settings menu (TV mode)



Photos menu (USB mode)



Navigating the menus

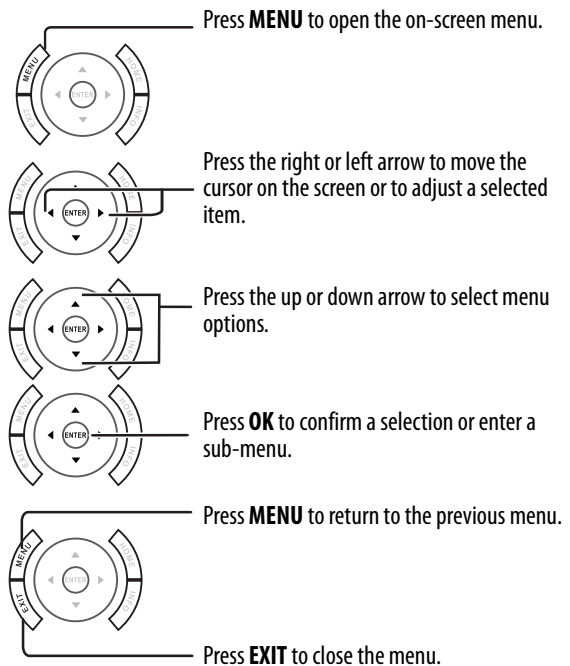

Selecting a channel

To select a channel:

- Press **CH** \wedge or **CH** \vee to go to the next or previous channel on the memorized channel list.
- Press the number buttons to enter the analog or main digital channel number you want, then wait for the channel to change or press **OK** to immediately change the channel.
- To select a digital sub-channel, press the number buttons to select the main digital channel, press **.** (dot), then press the number button for the sub-channel. Wait for the channel to change, or press **OK** to immediately change the channel. For example, to tune to channel 5.1, press **5**, **.** (dot), then **1**.

Note

Button presses must be within three seconds of each other.

- Press **○** (return) to go to the last viewed channel.
- Press **CH-LIST** to open the channel list, press \blacktriangle or \blacktriangledown to highlight a channel, then press **OK**. Hidden channels are grayed and cannot be selected. See "[Hiding channels](#)" on page 26.
- Press **FAVORITE** to open the favorite channel list, press \blacktriangle or \blacktriangledown to highlight a channel, then press **OK**.

Note

If a list has more than one page, press \blacktriangle OR \blacktriangledown to scroll through the pages.

Adjusting the volume

To adjust the volume:

- Press **VOL+** or **VOL-** to increase or decrease the volume.
- Press **MUTE** to turn off the sound. Press **MUTE** again to turn the sound back on.

Viewing channel information

To view channel information:

- Press **INFO** to view an information banner. The information banner shows the current program information such as channel number, video input source, and resolution.
 - Digital channel information—Displays the channel number, station name, channel label, broadcast program name, TV rating, signal type, audio information, resolution, CC mode, current time, and current program start and end times.
 - Analog channel information—Displays channel number, channel label (if present), signal type, audio information, and resolution.

Viewing system information

To view system information:

- 1 Press **MENU**. The on-screen menu opens.

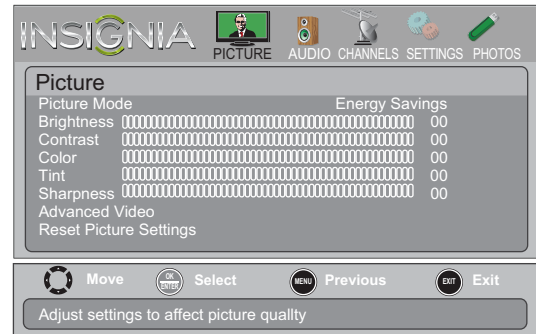

- 2 Press \blacktriangleleft or \blacktriangleright to highlight **SETTINGS**, then press \blacktriangledown or **OK**. The *Settings* menu opens.



- 3 Press \blacktriangle or \blacktriangledown to highlight **System Info**, then press **OK**. Information about the TV/DVD combo software version is displayed.
- 4 Press **MENU** to return to the previous menu, or press **EXIT** to close the menu.

Adjusting the picture

Adjusting the TV picture

To adjust the TV picture:

- 1 Press **MENU**. The on-screen menu opens with the *Picture* menu displayed.

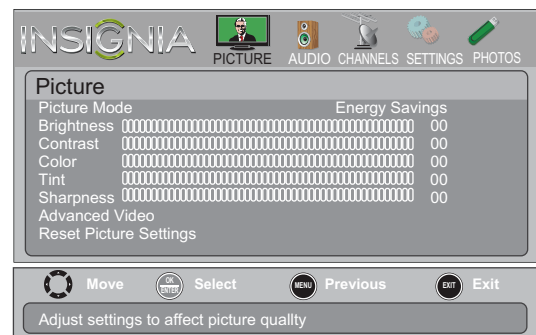

- 2 Press \blacktriangledown or **OK** to access the menu.
- 3 Press \blacktriangle or \blacktriangledown to highlight an option, then press **OK** to access the option. You can select:

- **Picture Mode**—Selects the picture mode. You can select:
 - **Vivid**—(a bright and vivid picture). Significantly increases the contrast, brightness, and sharpness. This selection is good for video games, animation, and in bright light environments.
 - **Standard**—(a standard picture). Moderately increases the contrast, brightness, and sharpness. This selection is good for standard TV broadcasts.
 - **Energy Savings**—(the backlight brightness is decreased). Your TV/DVD combo has a backlight that provides light for displaying a picture. By reducing the amount of light, your TV/DVD combo uses less energy.
 - **Theater**—(a finely detailed picture). Adjusts the brightness and contrast and lowers the sharpness for a more realistic picture. This selection is good for watching the highest quality video such as Blu-ray Discs, DVDs, and HDTV.
 - **Custom**—(customized picture). Lets you manually adjust picture settings such as brightness, contrast, and sharpness.

Note

You can also press **PICTURE** to select the picture mode.

- **Brightness**—Adjusts the brightness of the dark areas of the picture.
- **Contrast**—Adjusts the brightness of the light areas of the picture.
- **Color**—Adjusts the color intensity of the picture. A low setting may make the color look faded. A high setting may make the color look artificial.
- **Tint**—Adjusts the color balance of the picture. Use this control to make skin tones look more natural.
- **Sharpness**—Adjusts the color detail of images. If you set this control too high, dark images may appear with light or white edges.
- **Advanced Video**—Opens the *Picture-Advanced Video* menu where you can adjust additional video options.



- **Backlight**—Sets the overall brilliance of the screen. When **Dynamic Backlight (DCR)** is turned on, you cannot change the **Backlight** setting.

- **Aspect Ratio**—Selects the aspect ratio of the picture.

Aspect ratio options	Example
<p>Normal: Displays the original 4:3 aspect ratio with vertical black bars on the left and right of the image.</p>	
<p>Zoom: Expands the image to fill the screen. The top and bottom of the image may be cropped.</p>	
<p>Wide: Use this option to view content recorded in a 16:9 (wide-screen) aspect ratio.</p>	
<p>Cinema: Stretches the image at the edges, but keeps a clear image in the center.</p>	
<p>Auto: Automatically adjusts the image based on the screen size and the TV program. Note: Auto is only available when Auto Zoom in the <i>Channels</i> menu is set to On.</p>	

Note

You can also press **ZOOM** to select the aspect ratio.

- **Color Temperature**—Selects the color temperature. You can select **Cool** (to enhance the blues), **Normal**, or **Warm** (to enhance the reds).
 - **Overscan**—Adjusts the picture's reproduction rate. You can select **On** or **Off**.
 - **Noise Reduction**—Selects the noise reduction mode to reduce picture noise (snow). You can select **Low**, **Middle**, **High**, or **Off**.
 - **Adaptive Contrast**—Automatically adjusts picture detail and brightness. You can select **On** or **Off**.
 - **Dynamic Backlight (DCR)**—Enhances the contrast ratio between light and dark areas of the picture. You can select **Off**, **Low**, or **High**.
 - **Reset Picture Settings**—Resets all picture settings to factory mode.
- 4 Press **◀** or **▶** to adjust the option, or press **▲** or **▼** to select a setting.
 - 5 Press **MENU** to return to the previous menu, or press **EXIT** to close the menu.

Adjusting the computer image

To adjust the computer image:

- 1 Make sure that your TV/DVD combo is in VGA mode. For more information, see [“Selecting the video input source”](#) on page 20.
- 2 Press **MENU**. The on-screen menu opens.

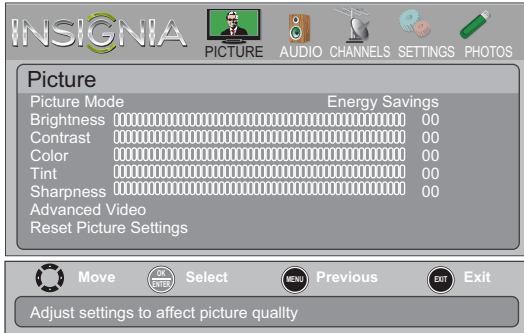

- 3 Press **◀** or **▶** to highlight **SETTINGS**, then press **OK**. The *Settings* menu opens.



- 4 Press **▲** or **▼** to highlight **Computer Settings**, then press **OK**. The *Settings-Computer Settings* menu opens.

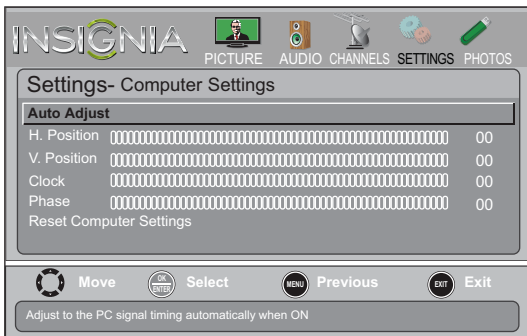

- 5 Press **▲** or **▼** to highlight an option, then press **OK** to access the option. You can select:
 - **Auto Adjust**—Automatically adjusts the image settings such as position and phase.
 - **H. Position**—Moves the image right or left.
 - **V. Position**—Moves the image up or down.
 - **Clock**—Adjusts the sample frequency.
 - **Phase**—Adjusts the focus of stable images.
 - **Reset Computer Settings**—Resets all computer settings to factory mode.

- 6 Press **◀** or **▶** to adjust the option, or press **▲** or **▼** to select a setting.
- 7 Press **MENU** to return to the previous menu, or press **EXIT** to close the menu.

Adjusting the sound

Adjusting sound settings

To adjust sound settings:

- 1 Press **MENU**. The on-screen menu opens.

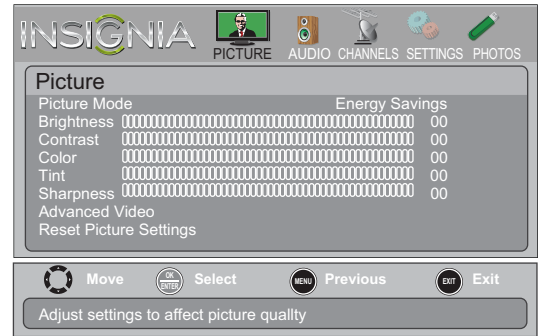

- 2 Press **◀** or **▶** to highlight **AUDIO**, then press **▼** or **OK**. The *Audio* menu opens.

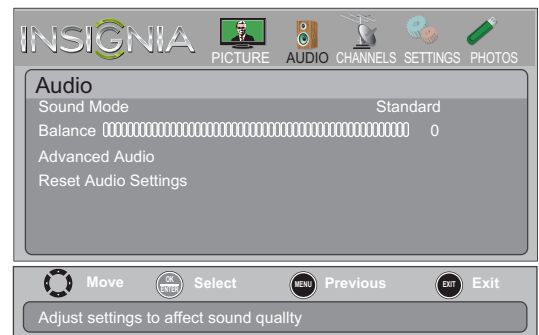

- 3 Press **▲** or **▼** to highlight an option, then press **OK** to access the option. You can select:
 - **Sound Mode**—Selects the sound mode. You can select:
 - **Standard**—Balances treble and bass. This setting is good for watching standard TV broadcasts.
 - **News**—Enhances vocals for TV audio. This setting is good for watching news broadcasts.
 - **Music**—Preserves the original sound. This setting is good for listening to music.
 - **Theater**—Enhances treble and bass for a rich sound experience. This setting is good for watching DVDs, Blu-ray discs, and HDTV.
 - **Custom**—Lets you manually adjust sound settings.

Note

You can also press **AUDIO** to select the sound mode.

- **Balance**—Adjusts the balance between the left and right audio channels.

- **Advanced Audio**—Opens the *Audio-Advanced Audio* menu where you can adjust additional audio options.



- **Bass**—Adjusts the low sounds.
- **Treble**—Adjusts the high sounds.
- **TV Speakers**—Selects where to play TV audio. You can select **On** (default setting) to play audio through TV speakers, or select **Off** to play audio through the speakers on an external audio system.
- **Digital Audio/SPDIF**—Sends digital audio to an external audio system. You can select **PCM** (to output audio in 2-channel stereo), or **RAW** (to pass through the original digital audio sound).
- **MTS/SAP**—(Analog channels only) Selects the audio mode. You can select:
 - **MONO**—Select this option if there is noise or static on weak stereo broadcasts.
 - **STEREO**—Select this option for programs broadcast in stereo.
 - **SAP**—Select this option to listen to a secondary audio program, if available.

Note

You can also press **MTS/SAP** on the remote control one or more times to select the audio mode.

- **Audio Language**—(Digital channels only) Selects an alternate audio language, if available.
 - **Reset Audio Settings**—Resets all audio settings to factory defaults.
- 4 Press **◀** or **▶** to adjust the option, or press **▲** or **▼** to select a setting.
 - 5 Press **MENU** to return to the previous menu, or press **EXIT** to close the menu.

Playing TV audio only

You can turn off the picture on your TV/DVD combo and listen to the program audio only.

To play TV audio only:

- 1 Press **MENU**. The on-screen menu opens.

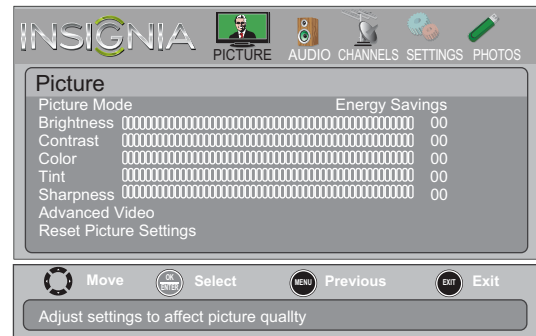

- 2 Press **◀** or **▶** to highlight **CHANNELS**, then press **▼** or **OK**. The *Channels* menu opens.

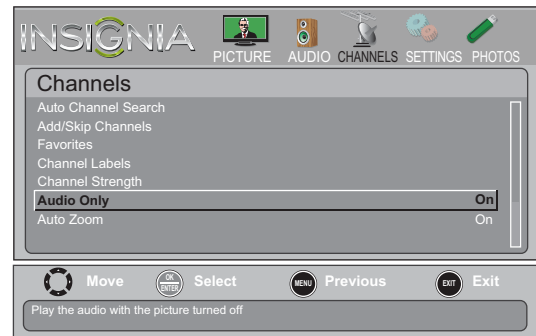

- 3 Press **▲** or **▼** to highlight **Audio Only**, then press **OK**.
- 4 Press **▲** or **▼** to select **On**.
- 5 Press **MENU** to return to the previous menu, or press **EXIT** to close the menu.

Notes

- **Audio Only** works only when the input source is TV, and your TV/DVD combo is receiving a broadcast signal.
- To exit audio only mode, press any button. When you exit audio only mode, the **Audio Only** option is automatically reset to **Off**.

Changing channel settings

Automatically scanning for channels

When you scan for channels, your TV/DVD combo searches for channels with signals and stores the channel information in the channel list. When you press **CH ▲** or **CH ▼**, your TV/DVD combo goes to the next or previous channel in the channel list. If the TV signal source changes, for example you change from an outdoor antenna to cable TV (no box), you need to scan for channels.

To automatically scan for channels:

1 Press **MENU**. The on-screen menu opens.

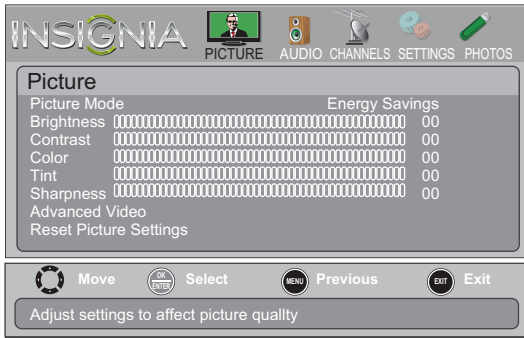

2 Press **◀** or **▶** to highlight **CHANNELS**, then press **▼** or **OK**. The *Channels* menu opens.

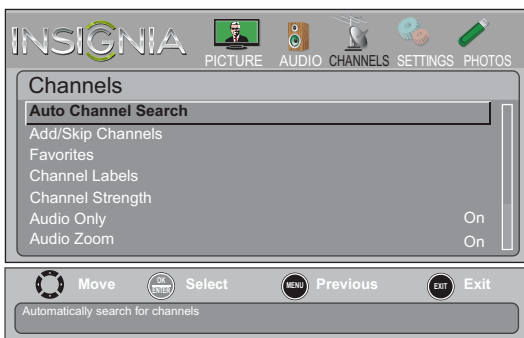

3 Press **▲** or **▼** to highlight **Auto Channel Search**, then press **OK**. The *Channels-Auto Channel Search* screen opens.

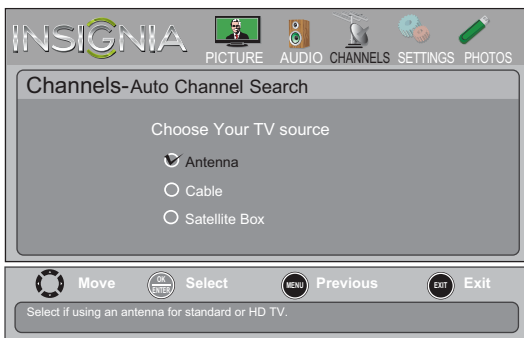

4 Press **▲** or **▼** to highlight **Antenna, Cable, or Satellite Box**, then press **OK**.

- A. If you select **Antenna**, your TV scans for available channels. The scan may take several minutes.
- B. If you select **Cable**, a message asks if you have a cable box.
 - Select **No** if no cable box is connected. Your TV scans for available channels. The scan may take several minutes.
 - Select **Yes** if a cable box is connected. A message asks how you connected the cable box to your TV.
 - Select **AV, Component, or HDMI** if you connected a cable box to your TV using one of these cables. Read the message, then press **OK** to close the wizard.

- Select **Coaxial** if you connected a cable box to your TV using a coaxial cable. Read the message, then press **OK** to start the channel scan (VHF channels only).

C. If you select **Satellite Box**, a message asks how you connected the satellite box to your TV.

- Select **AV, Component, or HDMI** if you connected a satellite box to your TV using one of these cables. Read the message, then press **OK** to close the wizard.
- Select **Coaxial** if you connected a satellite box to your TV using a coaxial cable. Read the message, then press **OK** to start the channel scan (VHF channels only).

Note

You can press **EXIT** to stop the auto channel search, but you will need to run the auto channel search again to create a channel list.

Hiding channels

You can hide channels in the channel list. When you press **CH▲** or **CH▼**, your TV/DVD combo skips the hidden channels. You can still tune to a hidden channel by pressing the number buttons for the channel.

To hide channels:

1 Press **MENU**. The on-screen menu opens.

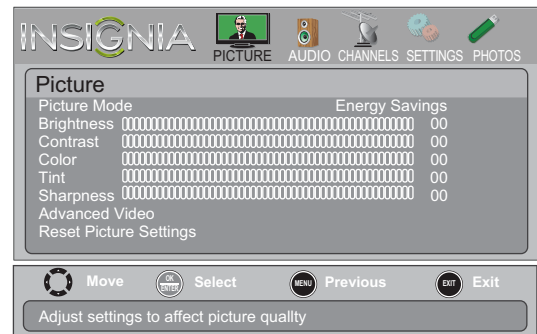

2 Press **◀** or **▶** to highlight **CHANNELS**, then press **▼** or **OK**. The *Channels* menu opens.



- Press **▲** or **▼** to highlight **Add/Skip Channels**, then press **OK**. The *Channels-Add/Skip Channels* screen opens.



- Press **▲** **▼** **◀** or **▶** to highlight the channel you want to hide, then press **OK**. The check mark disappears.

Notes

- A channel with a check mark is not hidden. A channel with no check mark is hidden.
- If the list has more than one page, press **▲** or **▼** to scroll through the pages.

- Press **MENU** to return to the previous menu, or press **EXIT** to close the menu.

Setting up a favorite channel list

You can create a favorite channel list so you can quickly browse through your favorite channels by pressing **FAVORITE**, then selecting a channel from the favorite channel list.

To set up a favorite channel list:

- Press **MENU**. The on-screen menu opens.

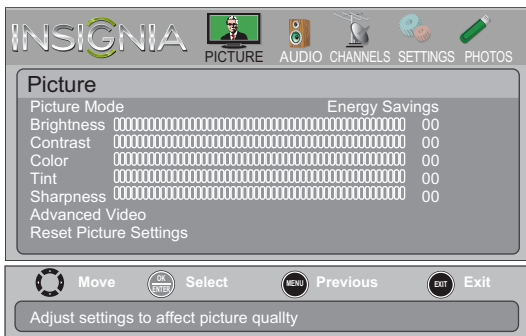

- Press **◀** or **▶** to highlight **CHANNELS**, then press **▼** or **OK**. The *Channels* menu opens.



- Press **▲** or **▼** to highlight **Favorites**, then press **OK**. The *Channels-Favorites* screen opens.



- Press **▲** **▼** **◀** or **▶** to highlight the channel you want to add to the favorites list, then press **OK**. A check mark appears next to the channel.

Notes

- To remove a channel from the favorites list, highlight the channel, then press **OK**. The check mark disappears and the channel is removed from the list.
- If the list has more than one page, press **▲** or **▼** to scroll through the pages.

- Press **MENU** to return to the previous menu, or press **EXIT** to close the menu.

Viewing a favorite channel

To view a favorite channel:

- Press **FAVORITE**. The favorite channel list opens.
- Press **▲** or **▼** to highlight a channel, then press **OK**.

Adding or changing a channel label

If a channel is not already labeled, you can label the channel to make it easier to identify. You can also relabel a channel that is already labeled.

To add or change a channel label:

- 1 Press **MENU**. The on-screen menu opens.

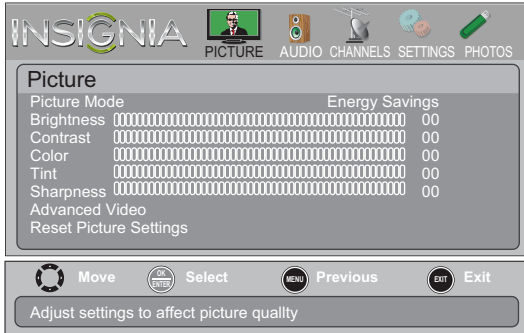

- 2 Press **◀** or **▶** to highlight **Channels**, then press **▼** or **OK**. The *Channels* menu opens.

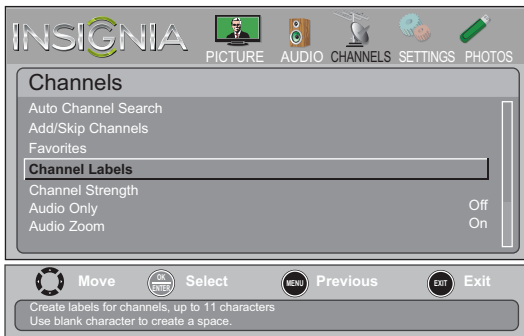

- 3 Press **▲** or **▼** to highlight **Channel Labels**, then press **OK**. The *Channels-Channel Labels* screen opens with the channel number field highlighted.



- 4 Press **▲** or **▼** to select the channel you want to label, then press **▶** to move to the channel label field.



- 5 Press **▲** or **▼** to select a character, then press **◀** or **▶** to move to the previous or next character position. Repeat this step to enter additional characters. You can enter as many as 11 characters.
- 6 When you have completed the label, press **MENU**.
- 7 Press **EXIT** to close the menu.

Checking the digital signal strength

You can check the digital signal strength to determine if you need to adjust your antenna or digital cable input. The higher the signal strength, the less likely you are to experience picture degradation.

To check the digital signal strength:

- 1 Press **MENU**. The on-screen menu opens.

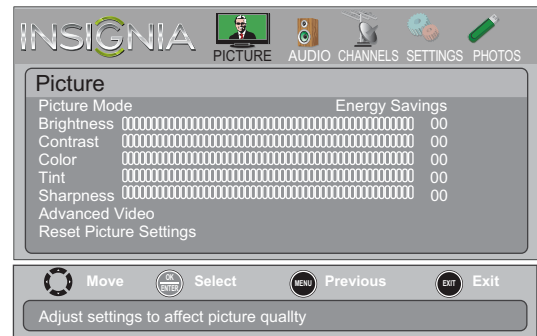

- 2 Press **◀** or **▶** to highlight **CHANNELS**, then press **▼** or **OK**. The *Channels* menu opens.

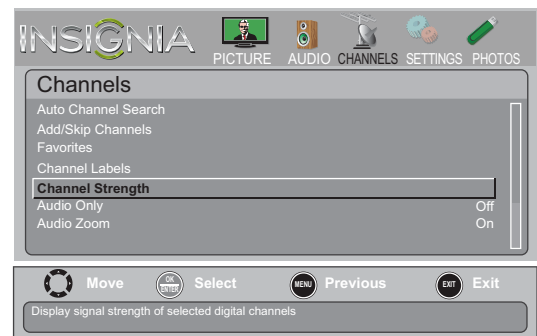

- 3 Press **▲** or **▼** to highlight **Channel Strength**, then press **OK**. The signal strength meter is displayed.



- 4 Press **MENU** to return to the previous menu, or press **EXIT** to close the menu.

Setting parental controls

Setting or changing the password

Parental controls let you prevent your children from watching inappropriate material on TV. When set, parental controls read the rating of the program (with some exceptions, such as news and sports) and deny access to programs that exceed the ratings level you select. To watch programs that exceed the selected rating, you must enter a password.

To set or change the password:

- 1 Press **MENU**. The on-screen menu opens.

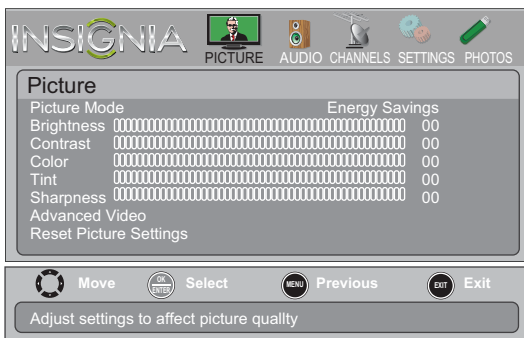

- 2 Press **◀** or **▶** to highlight **SETTINGS**, then press **▼** or **OK**. The *Settings* menu opens with **Parental Controls** highlighted.



- 3 Press **OK**. The *Enter Password* screen opens.



- 4 Press the number buttons to enter the four-digit password. The default password is **0000**. You should change the password to a number you can remember. The *Settings-Parental Controls* menu opens.



- 5 Press **▲** or **▼** to highlight **Change Password**, then press **OK**. The *Settings-Parental Controls-Change Password* screen opens.

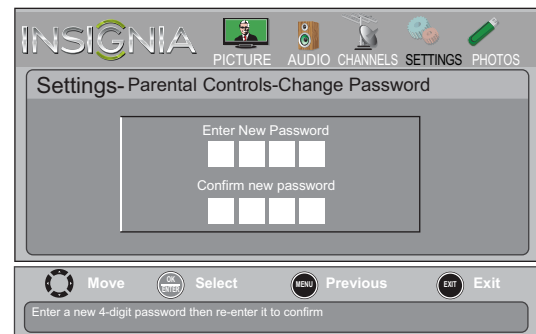

- 6 Press the number buttons to enter a password, then enter the password again.

Note

If you forget your password, enter **9999**.

- 7 Press **MENU** to return to the previous menu, or press **EXIT** to close the menu.

Locking control buttons

When the button lock is turned **On**, the buttons on the side of your TV/DVD combo are locked, and you can only operate your TV/DVD combo using the remote control.

To lock control buttons:

- 1 Press **MENU**. The on-screen menu opens.

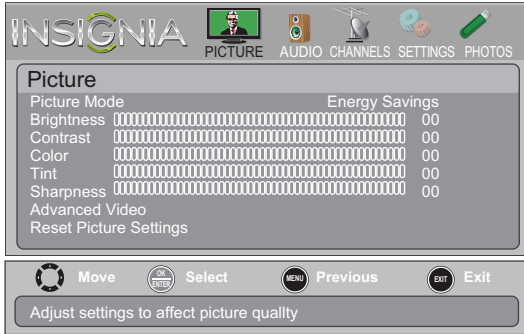

- 2 Press **◀** or **▶** to highlight **SETTINGS**, then press **▼** or **OK**. The *Settings* menu opens with **Parental Controls** highlighted.



- 3 Press **OK**. The *Enter Password* screen opens.



- 4 Press the number buttons to enter the four-digit password. The *Settings-Parental Controls* menu opens with **Button Lock** highlighted.



- 5 Press **OK**.
- 6 Press **▲** or **▼** to select **On** (locks the buttons) or **Off** (unlocks the buttons).
- 7 Press **MENU** to return to the previous menu, or press **EXIT** to close the menu.

Blocking unrated TV

To block unrated TV:

- 1 Press **MENU**. The on-screen menu opens.

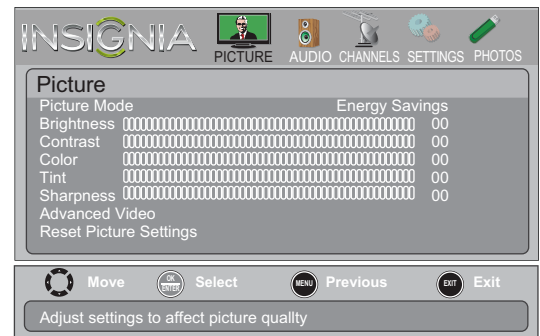

- 2 Press **◀** or **▶** to highlight **SETTINGS**, then press **▼** or **OK**. The *Settings* menu opens with **Parental Controls** highlighted.



- 3 Press **OK**. The *Enter Password* screen opens.



- 4 Press the number buttons to enter the four-digit password. The *Settings-Parental Controls* menu opens.

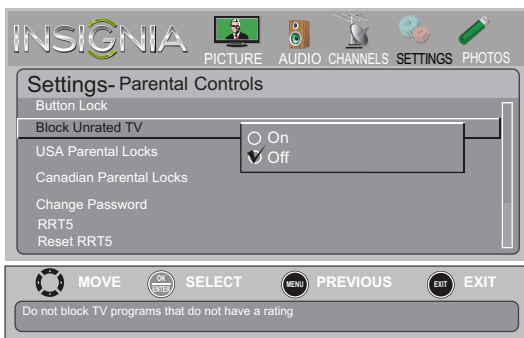

- 5 Press **▲** or **▼** to highlight **Block Unrated TV**, then press **OK**.
- 6 Press **▲** or **▼** to select **On** (to block unrated TV) or **Off** (to unblock unrated TV).
- 7 Press **MENU** to return to the previous menu, or press **EXIT** to close the menu.

Setting parental control levels

You can set parental controls for the U.S. and Canada.

U.S. rating levels

U.S. TV ratings

NONE	Not rated
TV-Y	All children
TV-Y7	Suitable for children 7 and older
TV-G	General audiences
TV-PG	Parental guidance suggested
TV-14	Parental guidance strongly suggested
TV-MA	Mature audiences only

Some of the age-based TV Parental Guidelines ratings also have content-based ratings.

U.S. TV content ratings

All	All ratings are blocked
FV	Fantasy violence
L	Strong language
S	Sexual situations
V	Violence
D	Suggestive dialog

U.S. movie (MPAA) ratings

None	Movie not rated
G	General audiences
PG	Parental guidance suggested
PG-13	Suitable for children 13 and older
R	Parental guidance suggested for children under 17
NC-17	Not suitable for children under 17
X	Adults only

Canadian rating levels

Canadian English ratings

E	Exempt programming
C	Suitable for all children
C8+	Suitable for children 8 and older
G	General audiences
PG	Parental guidance suggested
14+	Suitable for children 14 and older
18+	Adult only

Canadian French ratings

E	Exempt programming
G	General audiences
8ans+	Suitable for children 8 and older
13ans+	Suitable for children 13 and older
16ans+	Suitable for children 16 and older
18ans+	Adult only

To set parental control levels:

1 Press **MENU**. The on-screen menu opens.

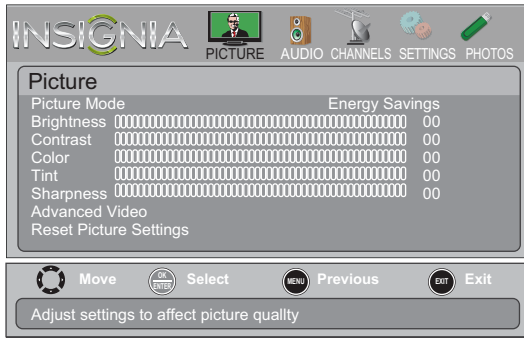

2 Press **◀** or **▶** to highlight **SETTINGS**, then press **▼** or **OK**. The *Settings* menu opens with **Parental Controls** highlighted.



3 Press **OK**. The *Enter Password* screen opens.



4 Press the number buttons to enter the four-digit password. The *Settings-Parental Controls* menu opens.



5 Press **▲** or **▼** to highlight **USA Parental Locks**, then press **OK**. (To set Canadian ratings, select **Canadian Parental Locks**.)

USA Parental Locks

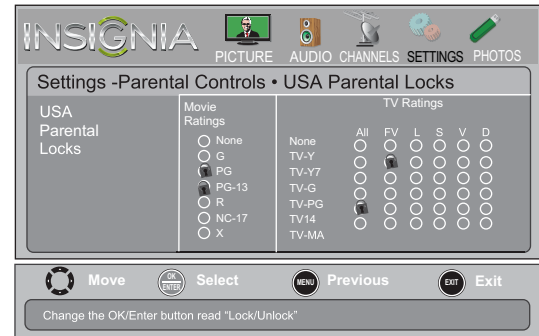

Canadian Parental Locks

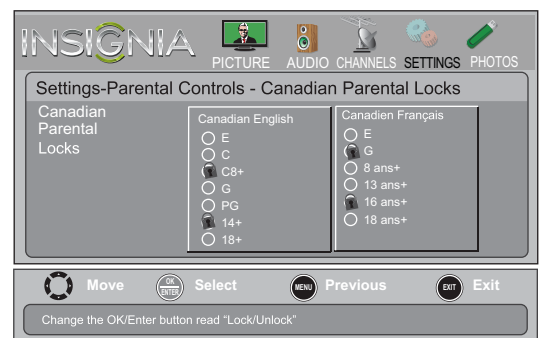

6 Press **◀** or **▶** to highlight:

- **Movie Ratings** or **TV Ratings** for USA ratings.
- **English Rating** or **French Rating** for Canadian ratings.

7 Press **▲** or **▼** to select the rating. If a rating has sub-ratings, press **◀** or **▶** to highlight a sub-rating.

Note
When you block a rating, that rating and all higher ratings are blocked.

8 Press **OK** to confirm. A lock symbol appears when a rating is blocked.

9 Press **MENU** to return to the previous menu, or press **EXIT** to close the menu.

Downloading rating information

You can download rating information to use when setting parental controls.

To download rating information:

- 1 Press **MENU**. The on-screen menu opens.

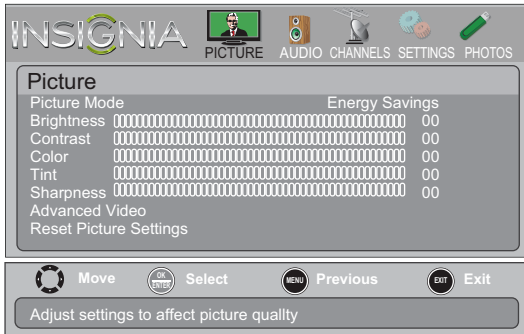

- 2 Press **◀** or **▶** to highlight **SETTINGS**, then press **▼** or **OK**. The *Settings* menu opens with **Parental Controls** highlighted.



- 3 Press **OK**. The *Enter Password* screen opens.



- 4 Press the number buttons to enter the four-digit password. The *Settings-Parental Controls* menu opens.



- 5 Press **▲** or **▼** to highlight **RRT5**, then press **OK**. If the program is broadcast with RRT5 rating information, the information is downloaded automatically and can be used for parental controls.
- 6 Press **MENU** to return to the previous menu, or press **EXIT** to close the menu.

Using closed captioning

Turning closed captioning on or off

To turn closed captioning on or off:

- 1 Press **MENU**. The on-screen menu opens.

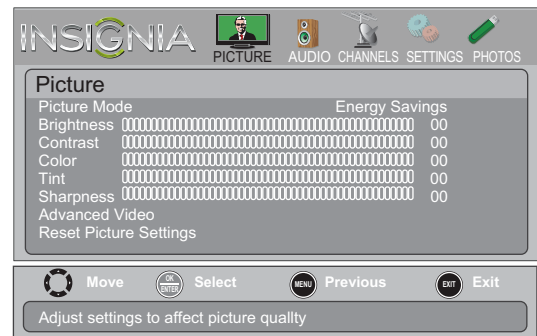

- 2 Press **◀** or **▶** to highlight **SETTINGS**, then press **▼** or **OK**. The *Settings* menu opens.



- Press **▲** or **▼** to highlight **Closed Caption**, then press **OK**. The *Settings-Closed Caption* menu opens.



- Press **▲** or **▼** to highlight **Closed Caption**, then press **OK**. The *Settings-Closed Caption* menu opens.



- Press **▲** or **▼** to highlight **Caption Control**, then press **OK**. A menu opens.
- Press **▲** or **▼** to select **CC Off** (turns off closed captioning), **CC On** (turns on closed captioning), or **CC on Mute** (turns on closed captioning when the sound is muted).
- Press **MENU** to return to the previous menu, or press **EXIT** to close the menu.

Note
You can also press **CCD** to turn closed captioning on or off.

- Press **▲** or **▼** to highlight **Analog Caption**, then press **OK**. A menu opens.



Selecting the analog closed captioning mode

To select the analog closed captioning mode:

- Press **MENU**. The on-screen menu opens.

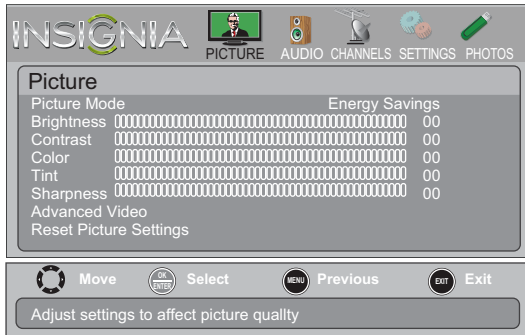

- Press **▲** or **▼** to select an analog caption setting. You can select:

- CC1 through CC4**—Closed captioning appears in a small banner across the bottom of the screen. **CC1** is usually the “printed” version of the audio. **CC2 through CC4** display content provided by the broadcaster.
- Text1 through Text4**—Closed captioning covers half or all of the screen. **Text1 through Text4** display content provided by the broadcaster.

- Press **MENU** to return to the previous menu, or press **EXIT** to close the menu.

Customizing digital closed captioning styles

To customize digital closed captioning styles:

- Press **MENU**. The on-screen menu opens.

- Press **◀** or **▶** to highlight **SETTINGS**, then press **▼** or **OK**. The *Settings* menu opens.

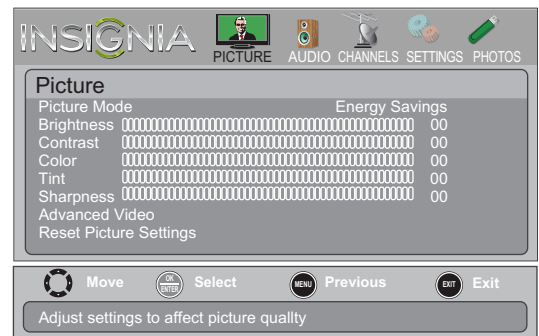

- Press **◀** or **▶** to highlight **SETTINGS**, then press **▼** or **OK**. The *Settings* menu opens.



- Press **▲** or **▼** to highlight **Closed Caption**, then press **OK**. The *Settings-Closed Caption* menu opens.



- Press **▲** or **▼** to highlight **Digital Caption**, then press **OK**. A menu opens.
- Press **▲** or **▼** to highlight a digital caption setting, then press **OK**. You can select **CS1** through **CS6**.
- Press **MENU** to return to the previous menu.
- Press **▲** or **▼** to highlight **Digital CC Settings**, then press **OK**. The *Settings-Closed Caption-Digital CC Settings* menu opens with **Style** highlighted.

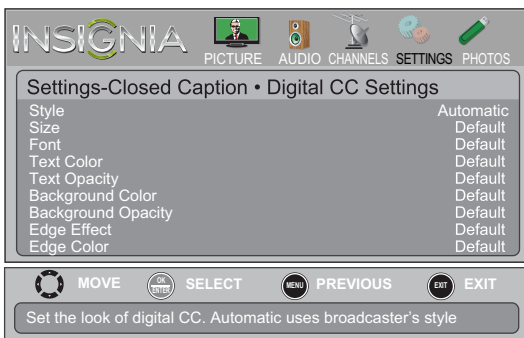

- Press **OK**, then press **◀** or **▶** to select **Custom**.

- Press **▲** or **▼** to highlight an option, then press **OK**. You can select:
 - Size**—Selects the font size.
 - Font**—Selects the font style.
 - Text Color**—Selects the color for the words.
 - Text Opacity**—Selects the opacity level for the words.
 - Background Color**—Selects the color for the background.
 - Background Opacity**—Selects the opacity level for the background.
 - Edge Effect**—Selects the edge style.
 - Edge Color**—Selects the edge color.
- Press **MENU** to return to the previous menu, or press **EXIT** to close the menu.

Adjusting time settings

Setting the clock

To set the clock:

- Press **MENU**. The on-screen menu opens.

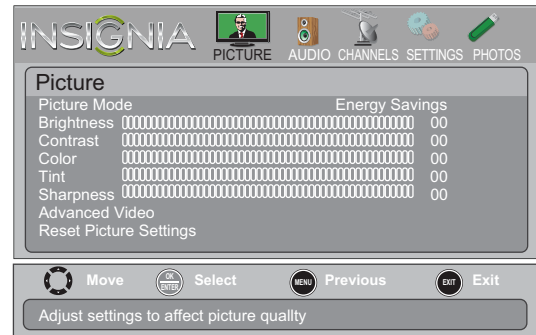

- Press **◀** or **▶** to highlight **SETTINGS**, then press **▼** or **OK**. The *Settings* menu opens.



- Press **▲** or **▼** to highlight **Time**, then press **OK**. The *Settings-Time* menu opens.



- Press **▲** or **▼** to highlight **Date/Time**, then press **OK**. The *Settings-Time-Date/Time* menu opens.



- Press **▲** or **▼** to highlight **Mode**, then press **OK**. A menu opens.
- Press **▲** or **▼** to highlight **Manual** (to set the date and time manually) or **Auto** (the date and time are automatically set by the TV signal source).
- Press **OK** to close the menu.
- Press **▲** or **▼** to highlight **Time Zone**, then press **OK**. The *Time-Time Zone* menu opens.
- Press **▲** or **▼** to select your time zone, then press **OK**. You can select **Eastern, Central, Mountain, Pacific, Alaska, Hawaii, Atlantic** or **Newfoundland**.
- Press **OK** to close the menu.
- If your viewing area observes daylight savings time, press **▲** or **▼** to highlight **Daylight Savings**, then press **OK**.
- Press **▲** or **▼** to select **On** or **Off**, then press **OK** to close the menu.
- If you selected **Manual** for **Mode**:
 - Press **▲** or **▼** to highlight **Year, Month, or Day**, then press **◀** or **▶** to adjust the setting, then press **OK**.
 - Press **▲** or **▼** to highlight **Time**, press **◀** or **▶** to highlight the hour, minute, or AM/PM field, then press **▲** or **▼** to adjust the setting. When you are finished, press **OK**.
- Press **MENU** to return to the previous menu, or press **EXIT** to close the menu.

Setting the sleep timer

You can specify the amount of time before your TV/DVD combo automatically turns off.

To set the sleep timer:

- Press **MENU**. The on-screen menu opens.

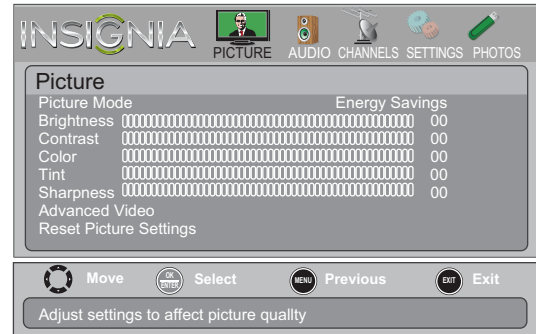

- Press **◀** or **▶** to highlight **SETTINGS**, then press **▼** or **OK**. The *Settings* menu opens.



- Press **▲** or **▼** to highlight **Time**, then press **OK**. The *Settings-Time* menu opens.



- Press **▲** or **▼** to highlight **Sleep Timer**, then press **OK**. A menu opens.
- Press **▲** or **▼** to select the amount of time before your TV/DVD combo turns off automatically. You can select **Off, 5 minutes, 10 minutes, 15 minutes, 30 minutes, 60 minutes, 90 minutes, 120 minutes, 180 minutes, or 240 minutes**. To turn off the sleep timer, select **Off**.
- Press **MENU** to return to the previous menu, or press **EXIT** to close the menu.

Note

You can also press **SLEEP** to set the sleep timer.

Adjusting menu settings

Selecting the menu language

To select the menu language:

- 1 Press **MENU**. The on-screen menu opens.

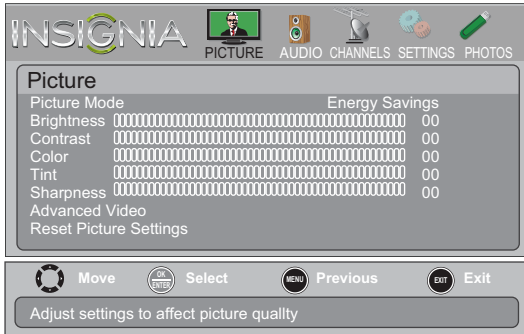

- 2 Press **◀** or **▶** to highlight **SETTINGS**, then press **▼** or **OK**. The *Settings* menu opens.



- 3 Press **▲** or **▼** to highlight **Menu Language**, then press **OK**. A menu opens.
- 4 Press **▲** or **▼** to highlight a language, then press **OK**. You can select **English**, **Français**, or **Español**.
- 5 Press **MENU** to return to the previous menu, or press **EXIT** to close the menu.

Turning the input sensor on or off

When the input sensor is turned on, your TV/DVD combo automatically detects which video jacks have devices connected to them. Your TV/DVD combo uses this information to determine what options you can select on the *INPUT SOURCE* list when you press **INPUT**.

To turn Input Sensor on or off:

- 1 Press **MENU**. The on-screen menu opens.

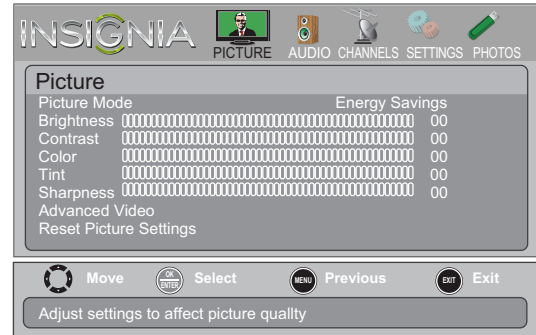

- 2 Press **◀** or **▶** to highlight **SETTINGS**, then press **▼** or **OK**. The *Settings* menu opens.



- 3 Press **▲** or **▼** to highlight **Auto Input Sensing**, then press **OK**. A menu opens.
- 4 Press **▲** or **▼** to select **On** (turns on the input sensor) or **Off** (turns off the input sensor).
- 5 Press **MENU** to return to the previous menu, or press **EXIT** to close the menu.

Labeling an input source

You can add a label to an input source to make it easier to identify.

To label an input source:

- 1 Press **MENU**. The on-screen menu opens.

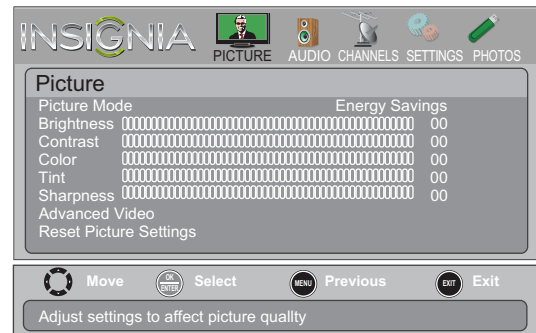

- Press **◀** or **▶** to highlight **SETTINGS**, then press **▼** or **OK**. The *Settings* menu opens.



- Press **▲** or **▼** to highlight **Input Labels**, then press **OK**. The *Settings-Input Labels* screen opens with the input source field highlighted.



- Press **▲** or **▼** to select the input source you want to label, then press **▶** to move to the custom label field.



- Press **▲** or **▼** to select a character, then press **◀** or **▶** to move to the previous or next character position. Repeat this step to enter additional characters. You can enter as many as 11 characters.
- When you have completed the label, press **MENU**. The next time you press **INPUT**, your label will appear in the *INPUT SOURCE* list.
- Press **EXIT** to close the menu.

Restoring settings to the defaults

When you restore default settings, all the settings you have customized (except the password and parental rating) are reset.

To restore settings to the defaults:

- Press **MENU**. The on-screen menu opens.

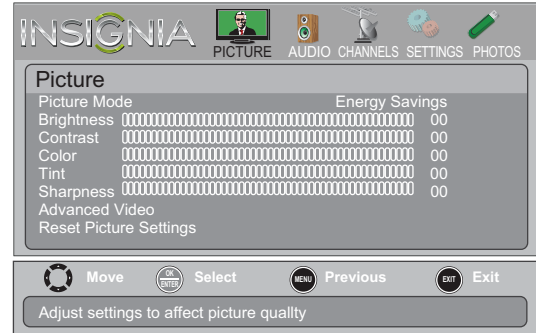

- Press **◀** or **▶** to highlight **SETTINGS**, then press **▼** or **OK**. The *Settings* menu opens.



- Press **▲** or **▼** to highlight **Reset to Default**, then press **OK**. A confirmation message opens.
- Press **◀** or **▶** to select **Yes** (to reset) or **No** (to not reset), then press **OK**.
- Press **MENU** to return to the previous menu, or press **EXIT** to close the menu.

Using a USB flash drive

You can connect a USB flash drive to your TV/DVD combo to view compatible JPEG pictures.

Notes

- Never remove the USB flash drive or turn off your TV/DVD combo while viewing JPEG pictures.
- The JPEG picture viewer only supports JPEG format images (with ".jpg" file extensions) and not all JPEG files are compatible with your TV/DVD combo.

Switching to USB mode

To switch to USB mode:

- Make sure that you have connected the USB flash drive to the USB port on your TV/DVD combo.
- Press **INPUT**. The *INPUT SOURCE* list opens.

- Press **▲** or **▼** to highlight **USB**, then press **OK**.

Note

To exit USB mode, press **INPUT** to open the **INPUT SOURCE** list, then select another input source, or press a Quick Launch Input button.

Browsing photos

To browse photos:

- Switch to USB mode. See "[Switching to USB mode](#)" on page 38.
- Press **MENU**. The on-screen menu opens.



- Press **OK**. The *Photos* menu opens.



- Press **▲** or **▼** to highlight **Browse Photos**, then press **OK**. The screen displays folder names and photo files stored on the USB flash drive in a thumbnail index with the first photo or folder highlighted. A control bar appears at the bottom of the screen.

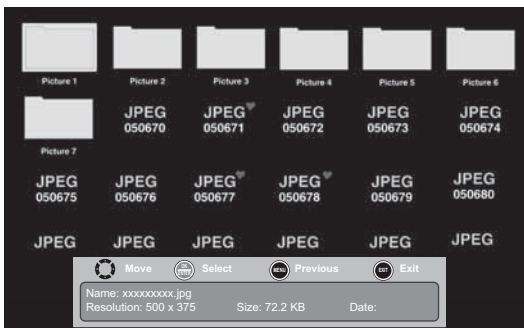

- To navigate the thumbnail index screen, press:
 - ▲ ▼ ◀ ▶** to browse through the files and folders.
 - OK** to view a highlighted photo full-screen or open a highlighted folder.

- MENU** to open the *Photo* menu.
- FAVORITE** to add or remove a photo from the favorite photo list. A heart appears on a photo that has been added to the favorite photo list.
- Press **EXIT** to close the control bar.

When a photo is displayed full-screen, a control bar appears at the bottom of the photo. The file name, picture resolution, size, and date are displayed on the bottom of the control bar. If you do not press a button within 10 seconds, the control bar closes. Press any button to open the control bar again.



- To navigate on the photo screen, press:

- ◀** or **▲** to go to the previous photo.
- ▶** or **▼** to go to the next photo.
- OK** to rotate the photo clockwise.
- ZOOM** one or more times to enlarge the image by 1x, 2x, or 4x or to select **Fill** (to fill the screen). You can press **▲ ▼ ◀ ▶** to pan the photo.
- EXIT** to return to the thumbnail index.
- MENU** to return to the *Photo* menu.

Viewing favorite photos

After you created your favorite photo list, you can browse among your favorite photos quickly.

To view favorite photos:

- Switch to USB mode. See "[Switching to USB mode](#)" on page 38.
- Press **MENU**. The on-screen menu opens.



3 Press **OK**. The *Photos* menu opens.



4 Press **▲** or **▼** to highlight **Favorite Photos**, then press **OK**. A thumbnail index of your favorite photos opens with a control bar at the bottom of the screen. A heart appears on a favorite photo.

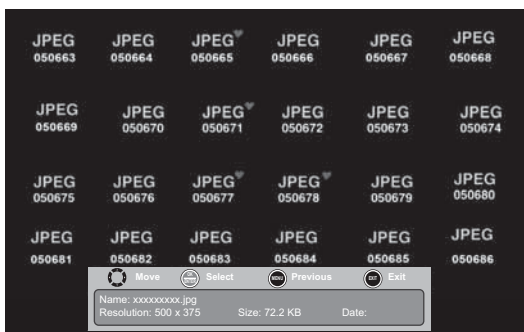

You select photos and navigate on the photo screen in the same way you do when you are browsing through photos. For more information, see "[Browsing photos](#)" on page 39.

Viewing photos in a slideshow

You can view your photos in a slideshow.

To view photos in a slideshow:

- 1 Switch to USB mode. See "[Switching to USB mode](#)" on page 38.
- 2 Press **MENU**. The on-screen menu opens.



3 Press **OK**. The *Photos* menu opens.



4 Press **▲** or **▼** to highlight **View Slideshow**, then press **OK**. A slideshow starts with the first photo in the current folder.

- 5 To control the slideshow, press:
 - **OK** to pause or start the slideshow.
 - **EXIT** to exit the slideshow and return to thumbnail index.
 - **MENU** to go to the *PHOTO* menu.

Customizing slideshow settings

You can customize the slideshow settings, including **Repeat**, **Shuffle**, **Speed**, and **Transition**.

To customize slideshow settings:

- 1 Switch to USB mode. See "[Switching to USB mode](#)" on page 38.
- 2 Press **MENU**. The on-screen menu opens.



3 Press **OK**. The *Photos* menu opens.



- Press **▲** or **▼** to highlight **Settings**, then press **OK**. The *Photos-Settings* menu opens.

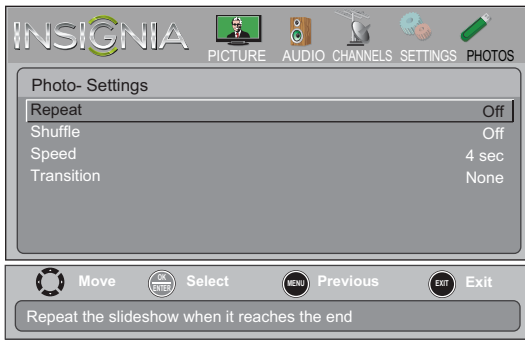

- Press **▲** or **▼** to highlight an option, then press **OK**. You can select:
 - Repeat**—Repeats the slideshow when it reaches the end. You can select **On** or **Off**.
 - Shuffle**—Displays the slideshow photos in random order. You can select **On** or **Off**.
 - Speed**—Sets the amount of time a photo is displayed before the slideshow moves to the next photo. You can select **4 Sec**, **6 Sec**, or **8 Sec**.
 - Transition**—Selects the way photos transition when moving to the next file in the slideshow. You can select:
 - None**—No transition effect.
 - Fade to Black**—Fades the screen to black between photos.
 - Vertical Wipe**—Wipes the screen from top to bottom between photos.
 - Horizontal Wipe**—Wipes the screen from left to right between photos.
 - Random**—Randomly selects a transition effect.
- Press **EXIT** to close the menu.

Using the DVD player

Most DVDs and your TV/DVD combo have region codes that help control illegal distribution of DVDs. The region code for your TV/DVD combo is **1**. You can only play DVDs with a region code of **1** or **ALL**. The region code for a DVD is printed on the DVD or the DVD packaging. See "DVD player" on page 48 for a list of compatible disc formats.

Warning

Keep your fingers clear of the disc slot when loading or unloading a disc. Neglecting to do so may cause serious personal injury.

Playing a disc

To play a disc:

- Press **⏻** (power) to turn on your TV/DVD combo.
- Press **INPUT**. The *INPUT SOURCE* list opens.
- Press **▲** or **▼** to highlight **DVD**, then press **OK**.

Note

- You can also press **DVD** to select DVD mode.
- If a disc is not in the disc slot when you switch to DVD mode, *NO DISC* appears on the screen.

- Insert a disc into the disc slot with the label facing backward. The picture next to the disc slot shows how to insert a disc. Playback begins automatically.

Note

When you insert a disc into the slot, the DVD player automatically pulls the disc into the slot. You do not need to force the disc into the slot.

Controlling disc playback

To control disc playback:

- Press **VOL+** or **VOL-** to adjust the volume.
- Press **▶||** (play/pause) to pause playback. Press again to resume playback.
- Press **◀◀** (skip back) to go to the previous chapter or track. Press **▶▶** (skip forward) to go to the next chapter or track.
- Press **◀◀** (fast reverse) to quickly move backward on a disc. Press **▶▶** (fast forward) to quickly move forward on a disc. Each time you press one of these buttons, the speed changes. The speeds are 2x, 4x, 8x, 16x, 32x. Press **▶||** (play/pause) to resume normal playback.
- Press **■** (stop) once to stop playback. If you press **▶||** (play/pause), playback resumes where the disc stopped. Press **■** (stop) twice. When you press **▶||** (play/pause), playback begins at the beginning.

Adjusting DVD player settings

To adjust DVD player settings:

- While in DVD mode and with playback stopped or not disc in the disc slot, press **SETUP**. A menu opens.
- Press **▲** or **▼** to highlight **OPTIONS MENU**, then press **OK**. The *General Setup Page* menu opens.



- Press **▲** or **▼** to select a setting or press **◀** or **▶** to select another menu, then press **OK**.
- When a setting is selected, press **◀** or **▶** to adjust the setting, then press **OK**.
- Press **SETUP** to close the menu.

DVD on-screen menus

General Setup Page

- **TV Display**—Select the screen aspect ratio. You can select **16:9**, or **Wide**.



- **OSD Lang**—Selects the language for the on-screen menus. You can select **English**, **French**, or **Spanish**.



- **Screen Saver**—When this setting is turned on and the DVD player is stopped or paused for a three minutes, a screen saver appears. To close the screen saver, press any DVD control button. You can select **On** or **Off**.

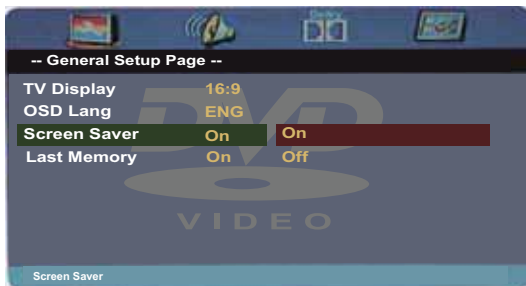

- **Last Memory**—If you turn off your TV with a disc in the disc slot or eject a disc when **Last Memory** is turned on, then turn on your TV or insert the same disc, playback resumes where it stopped. You can select **On** or **Off**.

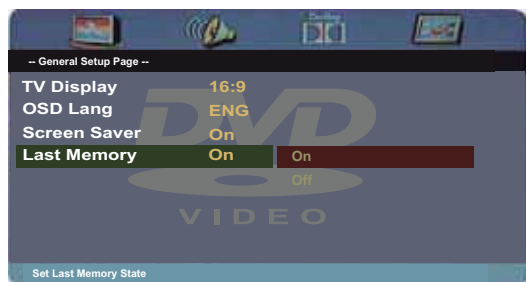

Audio Setup Page

Press **ENTER** or **▶** to access the **Speaker Setup** menu.



Downmix—You can select:

- **LT/RT**—Outputs the audio from a disc recorded with multi-channel audio to the left and right channels.
- **Stereo**—Outputs the audio from a disc recorded with multi-channel audio in stereo.

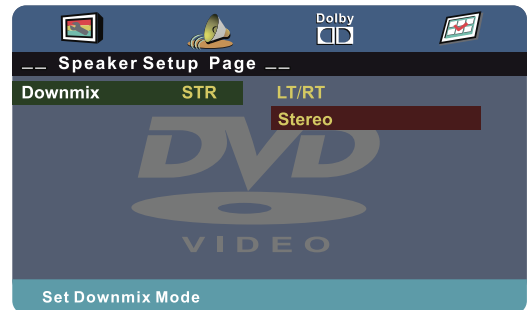

Dolby Digital Setup

- **Dynamic**—Sets the compression ratio to control the sound (volume) contrast. The sound contrast is the difference in volume between the loud and soft sounds on a disc's audio track.

Press **▲** or **▼** to select a compression ratio.



Preference Page

TV Type—You can select:

- **NTSC**—Displays the TV type. This information is for display only. You cannot change this option.



Note

This menu is only available when your TV/DVD combo is in DVD mode and playback is stopped or no disc is inserted.

Audio—Selects the audio language for the DVD, if the DVD was recorded in multiple languages.



Subtitle—Turns subtitles on or off and selects the DVD subtitle language, if the DVD was recorded with subtitles.

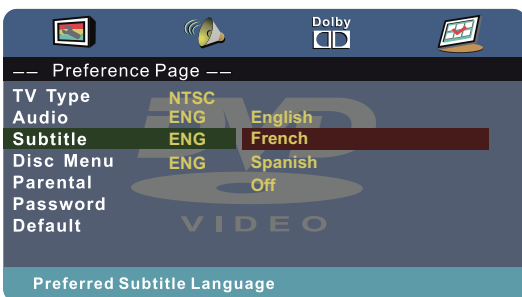

Disc Menu—Selects the language for the DVD menu if the DVD was recorded with multiple menu languages.

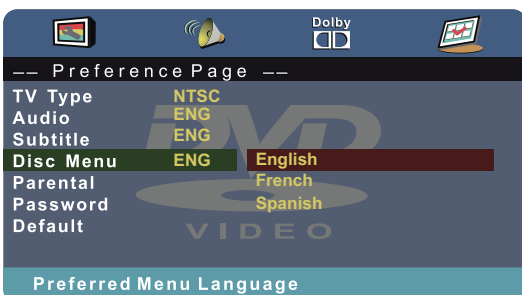

Parental—Sets the parental control rating level. When you select a level, DVDs recorded with the selected rating level or a higher rating level cannot be viewed. You can select:

- KIDSAFE
- G
- PG
- PG 13
- PGR
- R
- NC 17
- ADULT

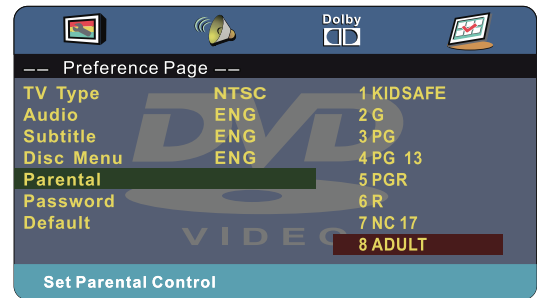

Password—Lets you set or change the parental control password. You must enter the password to set the parental rating level and to view DVDs with a locked rating level.

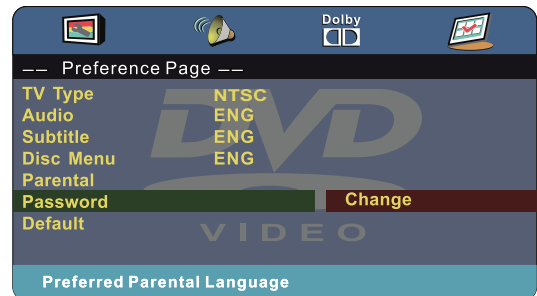

To change the password:

- 1 Select **Password**, then press ► to highlight **Change** and press **OK**. The password screen opens.



- 2 Use the number buttons on the remote control to enter the old password in the **Old Password** box. The default password is **(0000)**. If you forget your password, enter **9999**.
- 3 Press ▼ to move to the **New Password** box, then enter a new password.
- 4 Press ▼ to move to the **Confirm PWD** box, then enter the new password again.

Default—Resets all DVD settings, except the parental control setting and password, to the defaults.

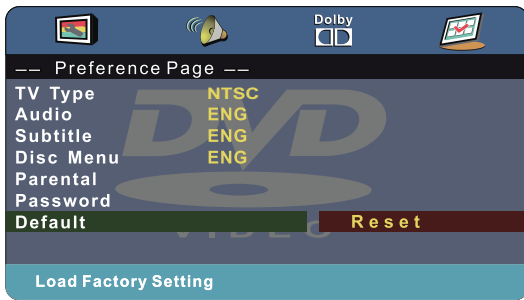

Cleaning discs

Fingerprints and dust on the disc can cause poor picture quality and sound distortion. Before playing, clean the disc with a clean cloth. Wipe the disc from the center out.



Maintaining

- Do not use your TV/DVD combo in areas that are too hot or too cold, because the cabinet may warp or the screen may malfunction. Your TV/DVD combo works best in temperatures that are comfortable to you.
- Storage temperatures are 32° to 122°F (0° to 50°C).
- Working temperatures are 41° to 104°F (5° to 40°C).
- Do not place your TV/DVD combo in direct sunlight or near a heat source.

Cleaning the TV/DVD combo cabinet

Clean the cabinet with a soft, lint-free cloth. If the cabinet is especially dirty, moisten a soft, lint-free cloth in a weak detergent solution, squeeze the excess moisture from the cloth, then wipe the cabinet with the cloth. Use a clean cloth to dry the cabinet.

Cleaning the TV screen

Clean the screen with a soft, lint-free cloth.

Care and handling of discs

Handling discs

Do not touch the playback side of the disc. Hold the disc by the edges so that fingerprints do not get on the surface. Never stick paper or tape on the disc.



Storing discs

After playing, store the disc in its case. Do not expose the disc to direct sunlight or sources of heat and never leave it in a parked car exposed to direct sunlight.

Troubleshooting

Warning

Do not try to repair your TV/DVD combo yourself. Contact authorized service personnel.

Video and audio

Problem	Solution
Picture does not fill the screen. There are black bars around the picture.	<ul style="list-style-type: none"> • Change the aspect ratio. An increasing amount of digital TV and movies are presented in wide screen (16:9). See "Aspect ratio options" on page 23.
No picture (screen is not lit) and no sound.	<ul style="list-style-type: none"> • Press on the TV/DVD combo or the remote control. • Make sure that the Audio Only option is set to Off. See "Playing TV audio only" on page 25. • Make sure that the video cables are connected securely to your TV/DVD combo. • Adjust the contrast and brightness. See "Adjusting the TV picture" on page 22. • Make sure that the power cord is plugged in. • Make sure that the correct video input source is selected. See "Selecting the video input source" on page 20. • Try another channel. The station may be experiencing problems. • Make sure that the incoming signal is compatible. • Make sure that the antenna or cable TV is connected correctly and securely. See "Connecting a cable or satellite box" on page 9 or "Connecting an antenna or cable TV (no box)" on page 12. • Check the closed caption settings. Some TEXT modes can block the screen.

Problem	Solution
Dark, poor, or no picture (screen is lit), but sound is good.	<ul style="list-style-type: none"> Try another channel. The station may be experiencing problems. Make sure that the antenna or cable TV is connected correctly and securely. See "Connecting a cable or satellite box" on page 9 or "Connecting an antenna or cable TV (no box)" on page 12. Adjust the brightness. See "Adjusting the TV picture" on page 22. Make sure that the correct picture mode is selected. See "Adjusting the TV picture" on page 22. If you are using an antenna, the digital channel signal may be low. To check the digital channel signal strength, see "Checking the digital signal strength" on page 28. If you are using an antenna and the signal strength is low, adjust the antenna or use a highly directional outdoor antenna or set-top antenna with a built-in amplifier. Make sure that the video cables are connected securely to your TV/DVD combo. The video cable(s) you are using may be bad. Try a new set. Try another channel. The station may be experiencing problems.
No color, dark picture, or color is not correct.	<ul style="list-style-type: none"> Try another channel. The station may be experiencing problems. Adjust the color settings. See "Adjusting the TV picture" on page 22. Make sure that the video cables are connected correctly and securely to your TV/DVD combo. Make sure that the antenna or cable TV is connected correctly and securely. See "Connecting a cable or satellite box" on page 9 or "Connecting an antenna or cable TV (no box)" on page 12. If you are using an antenna, the digital channel signal may be low. To check the digital channel signal strength, see "Checking the digital signal strength" on page 28. If you are using an antenna and the signal strength is low, adjust the antenna or use a highly directional outdoor antenna or set-top antenna with a built-in amplifier.
Only snow (noise) appears on the screen.	<ul style="list-style-type: none"> Try another channel. The station may be experiencing problems. Make sure that the antenna or cable TV is connected correctly and securely. See "Connecting a cable or satellite box" on page 9 or "Connecting an antenna or cable TV (no box)" on page 12. If you are using an antenna, the digital channel signal may be low. To check the digital channel signal strength, see "Checking the digital signal strength" on page 28. If you are using an antenna and the signal strength is low, adjust the antenna or use a highly directional outdoor antenna or set-top antenna with a built-in amplifier.
Picture quality is good on some channels and poor on others. Sound is good.	<ul style="list-style-type: none"> The problem may be caused by a poor or weak signal from the broadcaster or cable TV provider. If you connect to cable or satellite TV without a set-top box and experience poor picture quality, you may need to install a set-top box to improve signal reception and picture quality. Contact your cable or satellite TV provider about upgrading to a set-top box.

Problem	Solution
Dotted lines or stripes appear on the screen.	<ul style="list-style-type: none"> Make sure that the antenna or cable TV is connected correctly and securely. See "Connecting a cable or satellite box" on page 9 or "Connecting an antenna or cable TV (no box)" on page 12. If you are using an antenna, the digital channel signal may be low. To check the digital channel signal strength, see "Checking the digital signal strength" on page 28. If you are using an antenna and the signal strength is low, adjust the antenna or use a highly directional outdoor antenna or set-top antenna with a built-in amplifier. Make sure that the video cables are connected securely to your TV/DVD combo. The video cable(s) you are using may be bad. Try a new set. Other devices (for example, a surround sound receiver, external speakers, fans, or hair dryers) may be interfering with your TV/DVD combo. Try turning off one device at a time to determine which device is causing interference. After you have determined which device is causing interference, move it further from the TV/DVD combo to eliminate the interference.
Double images.	<ul style="list-style-type: none"> Use a highly directional outdoor antenna, cable TV, or satellite TV.
The picture has a few bright or dark spots.	<ul style="list-style-type: none"> A few bright or dark spots on an LCD screen is normal. It does not affect the operation of your TV/DVD combo.
Good picture, but no sound.	<ul style="list-style-type: none"> Increase the volume. Make sure that the sound is not muted. Make sure you do not have headphones connected. When headphones are connected, no sound comes from the TV/DVD combo speakers. Make sure that the correct audio mode is selected. Make sure that the audio cables are connected correctly and securely to your TV/DVD combo. Make sure that the antenna or cable TV is connected correctly and securely. See "Connecting a cable or satellite box" on page 9 or "Connecting an antenna or cable TV (no box)" on page 12. If you are using an antenna, the digital channel signal may be low. To check the digital channel signal strength, see "Checking the digital signal strength" on page 28. The audio cable(s) you are using may be bad. Try a new set.
Poor picture.	<ul style="list-style-type: none"> Make sure that the room is not too bright. Light reflecting off the screen can make the picture difficult to see. If an S-VHS camera or a camcorder is connected while another connected device is turned on, the picture may be poor. Turn off one or more devices.
Good sound but poor color.	<ul style="list-style-type: none"> Adjust the contrast, color, and brightness settings. See "Adjusting the TV picture" on page 22.
Audio noise.	<ul style="list-style-type: none"> Other devices (for example, a surround sound receiver, external speakers, fans, or hair dryers) may be interfering with your TV/DVD combo. Try turning off one device at a time to determine which device is causing interference. After you have determined which device is causing interference, move it further from the TV/DVD combo to eliminate the interference.

Problem	Solution
No output from one of the speakers.	<ul style="list-style-type: none"> Adjust the audio balance. See "Adjusting sound settings" on page 24. Make sure that the audio cables are connected correctly and securely to your TV/DVD combo.
After images appear.	<ul style="list-style-type: none"> Do not display a still image, such as a logo, game, or computer image, for an extended period of time. This can cause a permanent after-image to be burned into the screen. This type of damage is not covered by your warranty.

Remote control

Problem	Solution
Remote control does not work.	<ul style="list-style-type: none"> Make sure that the power cord is correctly connected to your TV/DVD combo and a power outlet. Make sure that there are no obstructions between the remote control and the remote control sensor on the front of the TV/DVD combo. Point the remote control directly at the remote control sensor on your TV/DVD combo. For the location of the remote control sensor, see "Aiming the remote control" on page 18. The supplied batteries are wrapped tightly in clear plastic. Make sure that you have removed this plastic from the batteries. Make sure that the batteries are installed correctly. See "Installing remote control batteries" on page 18. Replace dead batteries with new batteries. See "Installing remote control batteries" on page 18.
Trouble programming your existing universal remote control.	<ul style="list-style-type: none"> See instructions and a table of common codes in "Programming a different universal remote control" on page 48. Codes are subject to change. For up-to-date codes, go to www.insigniaproducts.com/remotecodes. Replace dead batteries with new batteries. See "Installing remote control batteries" on page 18. Refer to the User Guide that accompanied your universal remote control and contact the manufacturer if problems persist.

General

Problem	Solution
No power.	<ul style="list-style-type: none"> Make sure that the power cord is correctly connected to your TV/DVD combo and a power outlet. Unplug the power cord, wait 60 seconds, then plug the cord back in and turn on your TV/DVD combo. Other devices (for example, a surround sound receiver, external speakers, fans, or hair dryers) may be interfering with your TV/DVD combo. Try turning off one device at a time to determine which device is causing interference. After you have determined which device is causing interference, move it further from the TV/DVD combo to eliminate the interference.

Problem	Solution
"No signal" error message is displayed.	<ul style="list-style-type: none"> Press INPUT and make sure that you have selected the correct input for the device or service you are trying to use. If you are using a cable or satellite box, use the remote that came with that box to change channels. Make sure that you have the correct input selected to view channels from the cable or satellite box.
After Auto Channel Search, there are no channels.	<ul style="list-style-type: none"> Reception can vary by channel depending on the broadcast power level of a given station. Contact your cable or satellite TV provider. Make sure that the antenna or cable/satellite TV is connected securely to your TV/DVD combo. Try replacing the cable between the antenna/cable or cable/satellite box and your TV/DVD combo.
One or more channels do not display.	<ul style="list-style-type: none"> Make sure that the channels are not blocked. See "Setting parental control levels" on page 31. Make sure that the channels are not hidden. The channel may have been deleted from the channel list. You can tune to the channel by pressing the number buttons or you can add the channel back to the channel list. See "Hiding channels" on page 26. If you are using a cable or satellite box, use the remote that came with that box to change channels. Make sure that you have the correct input selected to view channels from the cable or satellite box. If you are using an antenna, the digital channel signal may be low. To check the digital channel signal strength, see "Checking the digital signal strength" on page 28.
Password is lost.	<ul style="list-style-type: none"> Enter 9999 to access parental controls, then set a new password. See "Setting or changing the password" on page 29.
Some settings cannot be accessed.	<ul style="list-style-type: none"> If a setting is grayed, the setting is not available in the current video input mode.
TV/DVD combo cabinet creaks.	<ul style="list-style-type: none"> When the TV/DVD combo is in use, the temperature rises naturally and may cause the cabinet to expand or contract which can cause a creaking noise. This is not a malfunction.
Control buttons do not work.	<ul style="list-style-type: none"> Make sure that the Button Lock option is set to Off. See "Locking control buttons" on page 30. Unplug the power cord, wait a few seconds, then plug the cord back in and turn on your TV/DVD combo.
TV keeps turning off.	<ul style="list-style-type: none"> Make sure that the sleep timer is not turned on. See "Setting the sleep timer" on page 36.

Disc playback

Problem	Solution
Playback does not start.	<ul style="list-style-type: none"> Make sure that a disc is inserted in the disc slot. The disc may be dirty. Clean the disc. See "Cleaning discs" on page 44. The disc format may not be supported. For more information, see "DVD player" on page 48.
No picture.	<ul style="list-style-type: none"> Press INPUT and make sure that DVD is selected. For more information, see "Selecting the video input source" on page 20.

Problem	Solution
No sound.	<ul style="list-style-type: none"> Make sure that headphones are not connected to your TV/DVD combo. When headphones are connected the internal speakers are muted. If your TV is connected to a sound system, make sure that the volume on the sound system is turned up.
Picture is distorted during fast forwarding or reversing.	<ul style="list-style-type: none"> This is not a malfunction. When you resume normal playback the distortion should disappear.
Some playback features do not work.	<ul style="list-style-type: none"> Depending on the disc, some playback features such as stopping, skipping, or repeat playback may not work.
The audio language or subtitle language cannot be changed.	<ul style="list-style-type: none"> Not all discs have multiple languages. Check the disc menu or disc packaging.
No subtitles.	<ul style="list-style-type: none"> Press SUBTITLE and make sure that subtitles are set to on.

USB photo display

Problem	Solution
Photos are not displayed.	<ul style="list-style-type: none"> Make sure that your USB flash drive is connected securely to the USB jack on the back of your TV. See "Connecting a USB flash drive" on page 16. Press INPUT and make sure that USB (Photos) is selected. See "Selecting the video input source" on page 20. Make sure that the photos on the USB flash drive are JPEG image files with ".jpg" as the file extension.
Slideshow does not start.	<ul style="list-style-type: none"> Make sure that you select slideshow when you are in thumbnail mode. See "Viewing photos in a slideshow" on page 40.

Note

If the problem is not solved by using these troubleshooting instructions, turn off your TV/DVD combo, then turn it on again.

Specifications

Specifications are subject to change without notice.

Dimensions and weight

Without stand	22.8 × 3.9 × 15.1 in. (57.9 × 10 × 38.3) cm 10.98 lbs. (4.9 8 kg)
With Stand	22.8 × 7.9 × 16.4 in. (57.9 × 20 × 41.7) cm 11.46 lbs. (5.2 kg)

Screen

Screen size measured diagonally	23.6 in.
Display type	LCD
Panel 60 Hz vs. 120 Hz	60Hz
Display resolution	1080p
Panel resolution	1920 (H) × 1080 (V)
Aspect ratio	16:9
Contrast ratio (typical)–panel	800:1
Dynamic contrast ratio–list value	3000:1
Brightness (center typical) cd/m2	300 nits
Comb filter	3d y/c digital
Response time	6 ms
Horizontal viewing angle	160
Vertical viewing angle	150

Display resolutions

HDMI 1.3	1080p, 1080i, 720p, 480p, 480i
Component video	1080i, 720p, 480p, 480i

Tuner

Analog	NTSC
Digital	ATSC, 8-VSB, Clear-QAM

Inputs

HDMI/DVI	2 (back) E-EDID compliant HDCP compliant
Component video	1 (back)
Composite video	1 (back)
Shared audio (component and composite)	Yes
S-Video	No
PC/VGA	1 (back)
3.5mm PC audio input	1 (back)
USB	1 (back) Supports JPEG and firmware upgrade

Outputs

Video	No
Analog audio	No
Digital audio	1 coaxial (back)
WiFi	No
Ethernet	No
Headphone	1 (back)

Audio

Speakers	Number: 2 Watts per channel: 3W
-----------------	------------------------------------

Power

Power consumption	On: 63 W Standby: <1W
Power input	120V/60Hz

Miscellaneous

OSD languages	English, French, Spanish
INlink	No
Game Mode	No
ENERGY STAR qualified	No
Internet connectable	No
TV base screws	No
V-Chip (version 2.0)	Yes
Sleep timer	Yes
Channel labeling	Yes
VESA mount (mm) (horizontal × vertical)	100 × 100

Note

The length of the wall-mount screws vary depending on the wall-mount bracket you purchased. See the instructions that came with the wall-mount bracket for screw lengths.

DVD player

Tray vs. slot load	Slot load
Disc capacity	1
Progressive scan	Yes
Skip protection	No audio skipping during CD playback under typical usage conditions: for example, playback at maximum volume level, vibrations caused while using the controls on the unit.
Optical disc support	Supports: CD Digital Audio 12 cm, CD-R, CD-RW, DVD-Video 12 cm, DVD-R, DVD-RW, DVD+R, DVD+RW, DVD-R DL Dual Layer, DVD+R Dual Layer Does not support: CD Digital Audio 8 cm, DVD-Video 8 cm, DVD-RW Dual Layer, DVD+RW Dual Layer
Audio decoder	Supports: CD Digital Audio, Dolby Digital Does not support: Simulated Surround (e.g. SRS), MP3, WMA, WMA Lossless
Digital audio output formats supported via HDMI output	No
Digital audio output formats supported via coaxial/optical digital outputs (ATSC and DVD)	Supports: Linear PCM 2 channel, Linear PCM 5.1 channel, Dolby Digital Does not support: DTS, DTS HD Master Audio
Digital audio decode capability (HDMI output)	No
Digital audio decode capability (digital coaxial and optical outputs)	Supports: Dolby Digital to 2-channel downmix PCM Does not support: DTS to 2-channel downmix PCM
Video decoder	Supports: DVD Video Does not support: JPEG, WMV (Window Media Video) 9.1, VCD 1.1, VCD 2.0, SVCD, DivX, XviD

Programming universal remote controls

Programming a different universal remote control

You can operate your Insignia TV/DVD combo with a new or existing universal remote control.

To program a different universal remote control:

- 1 See the table in "[Common universal remote control codes](#)" for common codes. If you have problems programming your remote or need a different remote control code, visit www.insigniaproducts.com/remotecodes for the latest remote control code information.
- 2 Follow your universal remote control's instructions to enter the TV code you found in Step 1.

Tips

- If your universal remote control has a code search feature, run a code search to identify a code that matches your TV/DVD combo. See your universal remote control's instructions for details.
- If your universal remote control has a "Learn" feature, you can manually program it using the Insignia TV remote to "teach" the commands one at a time. See your universal remote control's instructions for details.

For additional help and information:

- Visit: <http://www.insigniaproducts.com/remotecodes>
- Call technical support for the universal remote control or cable/satellite company of the remote/set-top box you are trying to program.
- Call the Insignia Customer Care Center 1-877-467-4289.

Common universal remote control codes

The following is a list of the most common remote control codes. Codes for other remote controls are available online at: <http://www.insigniaproducts.com/remotecodes> or check with your cable or satellite TV provider for the remote control code.

Insignia TV codes for universal remote controls (for all Insignia TVs manufactured after Jan. 1, 2007)

Universal remote control makes and models	
One for All	0054
Phillips	0198, 0490
RCA	135
Sony	068, 069, 078, 096, 100, 164, 168, 229, 026
Set-top box makes and models	
Cablevision	068, 069, 078, 096, 100, 164, 168, 229, 026
Charter	2002, 1204, 1423, 1517, 0171, 1963, 0463, 1463, 0842, 1326, 167, 415, 424, 450, 456, 461, 507, 523, 567, 577, 586
Comcast	10171, 11204, 11326, 11463, 11517, 11641, 11780, 11785, 11892, 11963, 12002
Cox	1326, 1463
DirectTV	10171, 11204, 11326, 11517, 11564, 11641, 11963, 12002
Dish Network	720
Time Warner	400, 450, 461, 456, 10463, 1463, 0463
TiVo	0091
Verizon	0198, 0490

Tips

- The brand name is often visible on the front of the universal remote control, and the model number is often visible on the back.
- If your universal remote control isn't listed on the chart, refer to your universal remote control's instructions and try codes for the brands Orion, Emerson, Memorex, Sansui, Sylvania, or Zenith. You may need to try several codes before finding a match.

Legal notices

FCC Part 15

This device complies with Part 15 of the FCC Rules. Operation of this product is subject to the following two conditions: (1) this device may not cause harmful interference, and (2) this device must accept any interference received, including interference that may cause undesired operation.

This equipment has been tested and found to comply within the limits for a class B digital device, pursuant to Part 15 of the FCC Rules. These limits are designed to provide reasonable protection against harmful interference in a residential installation. This equipment generates, uses, and can radiate radio frequency energy and, if not installed and used in accordance with the instructions, may cause harmful interference to radio communications. However, there is no guarantee that interference will not occur in a particular installation. If this equipment does cause harmful interference to radio or television reception, which can be determined by turning the equipment off and on, the user is encouraged to try to correct the interference by one or more of the following measures:

- Reorient or relocate the receiving antenna.
- Increase the separation between the equipment and receiver.
- Connect the equipment into an outlet on a circuit different from that to which the receiver is connected.
- Consult the dealer or an experienced radio/TV technician for help.

FCC warning

Changes or modifications not expressly approved by the party responsible for compliance with the FCC Rules could void the user's authority to operate this equipment.

Cables

Connections to this device must be made with shielded cables with metallic RF/EMI connector hoods to maintain compliance with FCC Rules and Regulations.

Canada ICES-003 statement

This Class B digital apparatus complies with Canadian ICES-003. Standard Television Receiving Apparatus — Appareil de réception télévision ordinaire, Canada BETS-7 / NTMR-7

Dolby License Notice and Trademark Acknowledgement



Manufactured under license from Dolby Laboratories. Dolby and the double-D symbol are trademarks of Dolby Laboratories.

HDMI



HDMI, the HDMI logo, and High-Definition Multimedia Interface are trademarks or registered trademarks of HDMI Licensing LLC.

One-year limited warranty - Insignia Televisions

Definitions:

Insignia Products ("Insignia") warrants to you, the original purchaser of this new Insignia-branded television ("Product"), that the Product shall be free of defects in the original manufacturer of the material or workmanship for a period of one (1) year from the date of your purchase of the Product ("Warranty Period"). For this warranty to apply, your Product must be purchased in the United States or Canada from a Best Buy or Future Shop authorized dealer of Insignia brand products only that are packaged with this warranty statement.

How long does the coverage last?

The Warranty Period lasts for 1 year (365 days) from the date you purchased the Product. Your purchase date is printed on the receipt you received with the Product.

What does this warranty cover?

During the Warranty Period, if the original manufacture of the material or workmanship of the Product is determined to be defective by an authorized Insignia repair center or store personnel, Insignia will (at its sole option): (1) repair the Product with new or rebuilt parts; or (2) replace the Product at no charge with new or rebuilt comparable products or parts. Products and parts replaced under this warranty become the property of Insignia and are not returned to you. If service of Products or parts are required after the Warranty Period expires, you must pay all labor and parts charges. This warranty lasts as long as you own your Insignia Product during the Warranty Period. Warranty coverage terminates if you sell or otherwise transfer the Product.

How to obtain warranty service?

If you purchased the Product at a Best Buy or Future Shop retail store location and your television Product has a screen size of less than 42 inches, please take your original receipt and the Product to any Best Buy or Future Shop store. Make sure that you place the Product in its original packaging or packaging that provides the same amount of protection as the original packaging. If you purchased the Product from a Best Buy or Future Shop online web site, mail your original receipt and the Product to the address listed on the web site. Make sure that you put the Product in its original packaging or packaging that provides the same amount of protection as the original packaging.

To obtain in-home warranty service for a television with a screen 42 inches or larger, in the United States call 1-888-BESTBUY, Canada call 1-866-BESTBUY for Future Shop call 1-800-663-2275. Call agents will diagnose and correct the issue over the phone or will have a Insignia-approved repair technician dispatched to your home.

Where is the warranty valid?

This warranty is valid only in the United States and Canada at Best Buy or Future Shop branded retail stores or websites to the original purchaser of the product in the county where the original purchase was made.

What does the warranty not cover?

This warranty does not cover:

- Customer instruction/education
- Installation
- Set up adjustments
- Cosmetic damage
- Damage due to acts of God, such as power surges
- Accident(s)
- Misuse
- Abuse
- Negligence
- Commercial purposes/use, including but not limited to use in a place of business or in communal areas of a multiple dwelling condominium or apartment complex, or otherwise used in a place of other than a private home.
- Modification of any part of the Product, including the antenna
- Plasma display panel damaged by static (non-moving) images applied for lengthy periods (burn-in).
- Damage due to incorrect operation or maintenance

- Connection to an incorrect voltage or power supply
- Attempted repair by any person not authorized by Insignia to service the Product
- Products sold "as is" or "with all faults"
- Consumables, including but not limited to batteries (i.e. AA, AAA, C etc.)
- Products where the factory applied serial number has been altered or removed
- Loss or Theft of this product or any part of the product
- Up to three (3) pixel failures (dots that are dark or incorrectly illuminated) grouped in an area smaller than one tenth (1/10) of the display size or up to five (5) pixel failures throughout the display. (Pixel based displays may contain a limited number of pixels that may not function normally.)
- Failures or Damage caused by any contact including but not limited to liquids, gels or pastes.

REPAIR REPLACEMENT AS PROVIDED UNDER THIS WARRANTY IS YOUR EXCLUSIVE REMEDY FOR BREACH OF WARRANTY. INSIGNIA SHALL NOT BE LIABLE FOR ANY INCIDENTAL OR CONSEQUENTIAL DAMAGES FOR THE BREACH OF ANY EXPRESS OR IMPLIED WARRANTY ON THIS PRODUCT, INCLUDING, BUT NOT LIMITED TO, LOST DATA, LOSS OF USE OF YOUR PRODUCT, LOST BUSINESS OR LOST PROFITS. INSIGNIA PRODUCTS MAKES NO OTHER EXPRESS WARRANTIES WITH RESPECT TO THE PRODUCT, ALL EXPRESS AND IMPLIED WARRANTIES FOR THE PRODUCT, INCLUDING, BUT NOT LIMITED TO, ANY IMPLIED WARRANTIES OF AND CONDITIONS OF MERCHANTABILITY AND FITNESS FOR A PARTICULAR PURPOSE, ARE LIMITED IN DURATION TO THE WARRANTY PERIOD SET FORTH ABOVE AND NO WARRANTIES, WHETHER EXPRESS OR IMPLIED, WILL APPLY AFTER THE WARRANTY PERIOD. SOME STATES, PROVINCES AND JURISDICTIONS DO NOT ALLOW LIMITATIONS ON HOW LONG AN IMPLIED WARRANTY LASTS, SO THE ABOVE LIMITATION MAY NOT APPLY TO YOU. THIS WARRANTY GIVES YOU SPECIFIC LEGAL RIGHTS, AND YOU MAY ALSO HAVE OTHER RIGHTS, WHICH VARY FROM STATE TO STATE OR PROVINCE TO PROVINCE.

Contact Insignia:

For customer service please call 1-877-467-4289

www.insigniaproducts.com

Distributed by Best Buy Purchasing, LLC

7601 Penn Avenue South, Richfield, Minnesota, U.S.A.
55423-3645

© 2012 BBY Solutions, Inc.

All rights reserved. INSIGNIA is a trademark of BBY Solutions, Inc. Registered in some countries. All other products and brand names are trademarks of their respective owners.

INSIGNIA™

www.insigniaproducts.com (877) 467-4289

Distributed by Best Buy Purchasing, LLC
7601 Penn Avenue South, Richfield, MN 55423-3645 USA
© 2012 BBY Solutions, Inc.

All rights reserved. INSIGNIA is a trademark of BBY Solutions, Inc. Registered in some countries.
All other products and brand names are trademarks of their respective owners.

ENGLISH
12-0994